

CHAPTER 16

STRUCTURAL DESIGN

SECTION 1601 GENERAL

1601.1 Scope. The provisions of this chapter shall govern the structural design of buildings, structures and portions thereof regulated by this code.

SECTION 1602 DEFINITIONS AND NOTATIONS

1602.1 Definitions. The following words and terms shall, for the purposes of this chapter, have the meanings shown herein.

ALLOWABLE STRESS DESIGN. A method of proportioning structural members, such that elastically computed stresses produced in the members by *nominal loads* do not exceed specified allowable stresses (also called “working stress design”).

➔ **DEAD LOADS.** The weight of materials of construction incorporated into the building, including but not limited to walls, floors, roofs, ceilings, stairways, built-in partitions, finishes, cladding and other similarly incorporated architectural and structural items, and the weight of fixed service equipment, such as cranes, plumbing stacks and risers, electrical feeders, heating, ventilating and air-conditioning systems and automatic sprinkler systems.

➔ **DESIGN STRENGTH.** The product of the nominal strength and a resistance factor (or strength reduction factor).

DIAPHRAGM. A horizontal or sloped system acting to transmit lateral forces to the vertical-resisting elements. When the term “diaphragm” is used, it shall include horizontal bracing systems.

Diaphragm, blocked. In light-frame construction, a diaphragm in which all sheathing edges not occurring on a framing member are supported on and fastened to blocking.

Diaphragm boundary. In light-frame construction, a location where shear is transferred into or out of the diaphragm sheathing. Transfer is either to a boundary element or to another force-resisting element.

Diaphragm chord. A diaphragm boundary element perpendicular to the applied load that is assumed to take axial stresses due to the diaphragm moment.

Diaphragm flexible. A diaphragm is flexible for the purpose of distribution of story shear and torsional moment where so indicated in Section 12.3.1 of ASCE 7, as modified in Section 1613.6.1.

Diaphragm, rigid. A diaphragm is rigid for the purpose of distribution of story shear and torsional moment when the lateral deformation of the diaphragm is less than or equal to two times the average story drift.

DURATION OF LOAD. The period of continuous application of a given load, or the aggregate of periods of intermittent applications of the same load.

ESSENTIAL FACILITIES. Buildings and other structures that are intended to remain operational in the event of extreme environmental loading from flood, wind, snow or earthquakes.

FABRIC PARTITION. A partition consisting of a finished surface made of fabric, without a continuous rigid backing, that is directly attached to a framing system in which the vertical framing members are spaced greater than 4 feet (1219 mm) on center.

FACTORED LOAD. The product of a nominal load and a load factor.

GUARD. See Section 1002.1.

IMPACT LOAD. The load resulting from moving machinery, elevators, craneways, vehicles and other similar forces and kinetic loads, pressure and possible surcharge from fixed or moving loads.

LIMIT STATE. A condition beyond which a structure or member becomes unfit for service and is judged to be no longer useful for its intended function (serviceability limit state) or to be unsafe (strength limit state).

LIVE LOADS. Those loads produced by the use and occupancy of the building or other structure and do not include construction or environmental loads such as wind load, snow load, rain load, earthquake load, flood load or dead load.

LIVE LOADS (ROOF). Those loads produced (1) during maintenance by workers, equipment and materials; and (2) during the life of the structure by movable objects such as planters and by people.

LOAD AND RESISTANCE FACTOR DESIGN (LRFD). A method of proportioning structural members and their connections using load and resistance factors such that no applicable limit state is reached when the structure is subjected to appropriate load combinations. The term “LRFD” is used in the design of steel and wood structures.

LOAD EFFECTS. Forces and deformations produced in structural members by the applied loads.

LOAD FACTOR. A factor that accounts for deviations of the actual load from the *nominal load*, for uncertainties in the analysis that transforms the load into a load effect, and for the probability that more than one extreme load will occur simultaneously.

LOADS. Forces or other actions that result from the weight of building materials, occupants and their possessions, environmental effects, differential movement and restrained dimensional changes. Permanent loads are those loads in which variations over time are rare or of small magnitude, such as dead loads. All other loads are variable loads (see also “*Nominal loads*”).

NOMINAL LOADS. The magnitudes of the loads specified in this chapter (dead, live, soil, wind, snow, rain, flood and earthquake).

OCCUPANCY CATEGORY. A category used to determine structural requirements based on occupancy.

OTHER STRUCTURES. Structures, other than buildings, for which loads are specified in this chapter.

PANEL (PART OF A STRUCTURE). The section of a floor, wall or roof comprised between the supporting frame of two adjacent rows of columns and girders or column bands of floor or roof construction.

RESISTANCE FACTOR. A factor that accounts for deviations of the actual strength from the nominal strength and the manner and consequences of failure (also called “strength reduction factor”).

STRENGTH, NOMINAL. The capacity of a structure or member to resist the effects of loads, as determined by computations using specified material strengths and dimensions and equations derived from accepted principles of structural mechanics or by field tests or laboratory tests of scaled models, allowing for modeling effects and differences between laboratory and field conditions.

STRENGTH, REQUIRED. Strength of a member, cross section or connection required to resist factored loads or related internal moments and forces in such combinations as stipulated by these provisions.

STRENGTH DESIGN. A method of proportioning structural members such that the computed forces produced in the members by factored loads do not exceed the member design strength [also called “load and resistance factor design” (LRFD)]. The term “strength design” is used in the design of concrete and masonry structural elements.

VEHICLE BARRIER SYSTEM. A system of building components near open sides of a garage floor or ramp or building walls that act as restraints for vehicles.

NOTATIONS.

- D = Dead load.
- E = Combined effect of horizontal and vertical earthquake induced forces as defined in Section 12.4.2 of ASCE 7.
- F = Load due to fluids with well-defined pressures and maximum heights.
- F_a = Flood load in accordance with Chapter 5 of ASCE 7.
- H = Load due to lateral earth pressures, ground water pressure or pressure of bulk materials.
- L = Live load, except roof live load, including any permitted live load reduction.
- L_r = Roof live load including any permitted live load reduction.
- R = Rain load.
- S = Snow load.
- T = Self-straining force arising from contraction or expansion resulting from temperature change, shrinkage, moisture change, creep in component

materials, movement due to differential settlement or combinations thereof.

W = Load due to wind pressure.

**SECTION 1603
CONSTRUCTION DOCUMENTS**

1603.1 General. *Construction documents* shall show the size, section and relative locations of structural members with floor levels, column centers and offsets dimensioned. The design loads and other information pertinent to the structural design required by Sections 1603.1.1 through 1603.1.9 shall be indicated on the *construction documents*.

Exception: *Construction documents* for buildings constructed in accordance with the *conventional light-frame construction* provisions of Section 2308 shall indicate the following structural design information:

1. Floor and roof live loads.
2. Ground snow load, P_g .
3. Basic wind speed (3-second gust), miles per hour (mph) (m/s) and wind exposure.
4. *Seismic design category* and *site class*.
5. Flood design data, if located in *flood hazard areas* established in Section 1612.3.
6. Design load-bearing values of soils.

1603.1.1 Floor live load. The uniformly distributed, concentrated and impact floor live load used in the design shall be indicated for floor areas. Use of live load reduction in accordance with Section 1607.9 shall be indicated for each type of live load used in the design.

1603.1.2 Roof live load. The roof live load used in the design shall be indicated for roof areas (Section 1607.11).

1603.1.3 Roof snow load. The ground snow load, P_g , shall be indicated. In areas where the ground snow load, P_g , exceeds 10 pounds per square foot (psf) (0.479 kN/m²), the following additional information shall also be provided, regardless of whether snow loads govern the design of the roof:

1. Flat-roof snow load, P_f .
2. Snow exposure factor, C_e .
3. Snow load importance factor, I .
4. Thermal factor, C_t .

1603.1.4 Wind design data. The following information related to wind loads shall be shown, regardless of whether wind loads govern the design of the lateral-force-resisting system of the building:

1. Basic wind speed (3-second gust), miles per hour (m/s).
2. Wind importance factor, I , and *occupancy category*.
3. Wind exposure. Where more than one wind exposure is utilized, the wind exposure and applicable wind direction shall be indicated.

4. The applicable internal pressure coefficient.
5. Components and cladding. The design wind pressures in terms of psf (kN/m²) to be used for the design of exterior component and cladding materials not specifically designed by the *registered design professional*.

1603.1.5 Earthquake design data. The following information related to seismic loads shall be shown, regardless of whether seismic loads govern the design of the lateral-force-resisting system of the building:

1. Seismic importance factor, *I*, and *occupancy category*.
2. Mapped spectral response accelerations, *S_S* and *S_I*.
3. *Site class*.
4. Spectral response coefficients, *S_{DS}* and *S_{DI}*.
5. *Seismic design category*.
6. Basic seismic-force-resisting system(s).
7. Design base shear.
8. Seismic response coefficient(s), *C_S*.
9. Response modification factor(s), *R*.
10. Analysis procedure used.

1603.1.6 Geotechnical information. The design load-bearing values of soils shall be shown on the *construction documents*.

1603.1.7 Flood design data. For buildings located in whole or in part in *flood hazard areas* as established in Section 1612.3, the documentation pertaining to design, if required in Section 1612.5, shall be included and the following information, referenced to the datum on the community's Flood Insurance Rate Map (FIRM), shall be shown, regardless of whether flood loads govern the design of the building:

1. In *flood hazard areas* not subject to high-velocity wave action, the elevation of the proposed lowest floor, including the basement.
2. In *flood hazard areas* not subject to high-velocity wave action, the elevation to which any nonresidential building will be dry floodproofed.
3. In *flood hazard areas* subject to high-velocity wave action, the proposed elevation of the bottom of the lowest horizontal structural member of the lowest floor, including the basement.

1603.1.8 Special loads. Special loads that are applicable to the design of the building, structure or portions thereof shall be indicated along with the specified section of this code that addresses the special loading condition.

1603.1.9 Systems and components requiring special inspections for seismic resistance. *Construction documents* or specifications shall be prepared for those systems and components requiring *special inspection* for seismic resistance as specified in Section 1707.1 by the *registered design professional* responsible for their design and shall be submitted for approval in accordance with Section 107.1.

Reference to seismic standards in lieu of detailed drawings is acceptable. ←

**SECTION 1604
GENERAL DESIGN REQUIREMENTS**

1604.1 General. Building, structures and parts thereof shall be designed and constructed in accordance with strength design, *load and resistance factor design*, *allowable stress design*, empirical design or conventional construction methods, as permitted by the applicable material chapters.

1604.2 Strength. Buildings and other structures, and parts thereof, shall be designed and constructed to support safely the factored loads in load combinations defined in this code without exceeding the appropriate strength limit states for the materials of construction. Alternatively, buildings and other structures, and parts thereof, shall be designed and constructed to support safely the *nominal loads* in load combinations defined in this code without exceeding the appropriate specified allowable stresses for the materials of construction.

Loads and forces for occupancies or uses not covered in this chapter shall be subject to the approval of the *building official*.

1604.3 Serviceability. Structural systems and members thereof shall be designed to have adequate stiffness to limit deflections and lateral drift. See Section 12.12.1 of ASCE 7 for drift limits applicable to earthquake loading.

1604.3.1 Deflections. The deflections of structural members shall not exceed the more restrictive of the limitations of Sections 1604.3.2 through 1604.3.5 or that permitted by Table 1604.3.

**TABLE 1604.3
DEFLECTION LIMITS^{a, b, c, h, i}**

CONSTRUCTION	<i>L</i>	<i>S</i> or <i>W</i> ^f	<i>D</i> + <i>L</i> ^{d, g}
Roof members: ^e			
Supporting plaster ceiling	//360	//360	//240
Supporting nonplaster ceiling	//240	//240	//180
Not supporting ceiling	//180	//180	//120
Floor members	//360	—	//240
Exterior walls and interior partitions:			
With brittle finishes	—	//240	—
With flexible finishes	—	//120	—
Farm buildings	—	—	//180
Greenhouses	—	—	//120

For SI: 1 foot = 304.8 mm.

- a. For structural roofing and siding made of formed metal sheets, the total load deflection shall not exceed //60. For secondary roof structural members supporting formed metal roofing, the live load deflection shall not exceed //150. For secondary wall members supporting formed metal siding, the design wind load deflection shall not exceed //90. For roofs, this exception only applies when the metal sheets have no roof covering.
- b. Interior partitions not exceeding 6 feet in height and flexible, folding and portable partitions are not governed by the provisions of this section. The deflection criterion for interior partitions is based on the horizontal load defined in Section 1607.13.
- c. See Section 2403 for glass supports.

(Table notes continued)

- d. For wood structural members having a moisture content of less than 16 percent at time of installation and used under dry conditions, the deflection resulting from $L + 0.5D$ is permitted to be substituted for the deflection resulting from $L + D$.
- e. The above deflections do not ensure against ponding. Roofs that do not have sufficient slope or camber to assure adequate drainage shall be investigated for ponding. See Section 1611 for rain and ponding requirements and Section 1503.4 for roof drainage requirements.
- f. The wind load is permitted to be taken as 0.7 times the "component and cladding" loads for the purpose of determining deflection limits herein.
- g. For steel structural members, the dead load shall be taken as zero.
- h. For aluminum structural members or aluminum panels used in skylights and sloped glazing framing, roofs or walls of sunroom additions or patio covers, not supporting edge of glass or aluminum sandwich panels, the total load deflection shall not exceed $l/60$. For continuous aluminum structural members supporting edge of glass, the total load deflection shall not exceed $l/175$ for each glass lite or $l/60$ for the entire length of the member, whichever is more stringent. For aluminum sandwich panels used in roofs or walls of sunroom additions or patio covers, the total load deflection shall not exceed $l/120$.
- i. For cantilever members, l shall be taken as twice the length of the cantilever.

1604.3.2 Reinforced concrete. The deflection of reinforced concrete structural members shall not exceed that permitted by ACI 318.

1604.3.3 Steel. The deflection of steel structural members shall not exceed that permitted by AISC 360, AISI S100, ASCE 3, ASCE 8, SJI CJ-1.0, SJI JG-1.1, SJI K-1.1 or SJI LH/DLH-1.1, as applicable.

1604.3.4 Masonry. The deflection of masonry structural members shall not exceed that permitted by TMS 402/ACI 530/ASCE 5.

1604.3.5 Aluminum. The deflection of aluminum structural members shall not exceed that permitted by AA ADM1.

1604.3.6 Limits. Deflection of structural members over span, l , shall not exceed that permitted by Table 1604.3.

1604.4 Analysis. *Load effects* on structural members and their connections shall be determined by methods of structural analysis that take into account equilibrium, general stability, geometric compatibility and both short- and long-term material properties.

Members that tend to accumulate residual deformations under repeated service loads shall have included in their analysis the added eccentricities expected to occur during their service life.

Any system or method of construction to be used shall be based on a rational analysis in accordance with well-established principles of mechanics. Such analysis shall result in a system that provides a complete load path capable of transferring loads from their point of origin to the load-resisting elements.

The total lateral force shall be distributed to the various vertical elements of the lateral-force-resisting system in proportion to their rigidities, considering the rigidity of the horizontal bracing system or diaphragm. Rigid elements assumed not to be a part of the lateral-force-resisting system are permitted to be incorporated into buildings provided their effect on the action of the system is considered and provided for in the design. Except where diaphragms are flexible, or are permitted to be analyzed as flexible, provisions shall be made for the increased forces induced on resisting elements of the structural

system resulting from torsion due to eccentricity between the center of application of the lateral forces and the center of rigidity of the lateral-force-resisting system.

Every structure shall be designed to resist the overturning effects caused by the lateral forces specified in this chapter. See Section 1609 for wind loads, Section 1610 for lateral soil loads and Section 1613 for earthquake loads.

1604.5 Occupancy category. Each building and structure shall be assigned an *occupancy category* in accordance with Table 1604.5.

1604.5.1 Multiple occupancies. Where a building or structure is occupied by two or more occupancies not included in the same *occupancy category*, it shall be assigned the classification of the highest *occupancy category* corresponding to the various occupancies. Where buildings or structures have two or more portions that are structurally separated, each portion shall be separately classified. Where a separated portion of a building or structure provides required access to, required egress from or shares life safety components with another portion having a higher *occupancy category*, both portions shall be assigned to the higher *occupancy category*.

1604.6 In-situ load tests. The *building official* is authorized to require an engineering analysis or a load test, or both, of any construction whenever there is reason to question the safety of the construction for the intended occupancy. Engineering analysis and load tests shall be conducted in accordance with Section 1714.

1604.7 Preconstruction load tests. Materials and methods of construction that are not capable of being designed by *approved* engineering analysis or that do not comply with the applicable material design standards listed in Chapter 35, or alternative test procedures in accordance with Section 1712, shall be load tested in accordance with Section 1715.

1604.8 Anchorage.

1604.8.1 General. Anchorage of the roof to walls and columns, and of walls and columns to foundations, shall be provided to resist the uplift and sliding forces that result from the application of the prescribed loads.

1604.8.2 Walls. Walls shall be anchored to floors, roofs and other structural elements that provide lateral support for the wall. Such anchorage shall provide a positive direct connection capable of resisting the horizontal forces specified in this chapter but not less than the minimum strength design horizontal force specified in Section 11.7.3 of ASCE 7, substituted for "E" in the load combinations of Section 1605.2 or 1605.3. Concrete and masonry walls shall be designed to resist bending between anchors where the anchor spacing exceeds 4 feet (1219 mm). Required anchors in masonry walls of hollow units or cavity walls shall be embedded in a reinforced grouted structural element of the wall. See Sections 1609 for wind design requirements and 1613 for earthquake design requirements.

1604.8.3 Decks. Where supported by attachment to an *exterior wall*, decks shall be positively anchored to the primary structure and designed for both vertical and lateral loads as applicable. Such attachment shall not be accomplished by

the use of toenails or nails subject to withdrawal. Where positive connection to the primary building structure cannot be verified during inspection, decks shall be self-supporting. Connections of decks with cantilevered framing members to exterior walls or other framing members shall be designed for both of the following:

1. The reactions resulting from the dead load and live load specified in Table 1607.1, or the snow load specified in Section 1608, in accordance with Section 1605, acting on all portions of the deck.
2. The reactions resulting from the dead load and live load specified in Table 1607.1, or the snow load specified in Section 1608, in accordance with Section 1605, acting on the cantilevered portion of the deck,

and no live load or snow load on the remaining portion of the deck.

1604.9 Counteracting structural actions. Structural members, systems, components and cladding shall be designed to resist forces due to earthquake and wind, with consideration of overturning, sliding and uplift. Continuous load paths shall be provided for transmitting these forces to the foundation. Where sliding is used to isolate the elements, the effects of friction between sliding elements shall be included as a force.

1604.10 Wind and seismic detailing. Lateral-force-resisting systems shall meet seismic detailing requirements and limitations prescribed in this code and ASCE 7, excluding Chapter 14 and Appendix 11A, even when wind *load effects* are greater than seismic *load effects*.

**TABLE 1604.5
OCCUPANCY CATEGORY OF BUILDINGS AND OTHER STRUCTURES**

OCCUPANCY CATEGORY	NATURE OF OCCUPANCY
I	Buildings and other structures that represent a low hazard to human life in the event of failure, including but not limited to: <ul style="list-style-type: none"> • Agricultural facilities. • Certain temporary facilities. • Minor storage facilities.
II	Buildings and other structures except those listed in Occupancy Categories I, III and IV
III	Buildings and other structures that represent a substantial hazard to human life in the event of failure, including but not limited to: <ul style="list-style-type: none"> • Buildings and other structures whose primary occupancy is public assembly with an occupant load greater than 300. • Buildings and other structures containing elementary school, secondary school or day care facilities with an occupant load greater than 250. • Buildings and other structures containing adult education facilities, such as colleges and universities, with an occupant load greater than 500. • Group I-2 occupancies with an occupant load of 50 or more resident patients but not having surgery or emergency treatment facilities. • Group I-3 occupancies. • Any other occupancy with an occupant load greater than 5,000^a. • Power-generating stations, water treatment facilities for potable water, waste water treatment facilities and other public utility facilities not included in Occupancy Category IV. • Buildings and other structures not included in Occupancy Category IV containing sufficient quantities of toxic or explosive substances to be dangerous to the public if released.
IV	Buildings and other structures designated as essential facilities, including but not limited to: <ul style="list-style-type: none"> • Group I-2 occupancies having surgery or emergency treatment facilities. • Fire, rescue, ambulance and police stations and emergency vehicle garages. • Designated earthquake, hurricane or other emergency shelters. • Designated emergency preparedness, communications and operations centers and other facilities required for emergency response. • Power-generating stations and other public utility facilities required as emergency backup facilities for Occupancy Category IV structures. • Structures containing highly toxic materials as defined by Section 307 where the quantity of the material exceeds the maximum allowable quantities of Table 307.1(2). • Aviation control towers, air traffic control centers and emergency aircraft hangars. • Buildings and other structures having critical national defense functions. • Water storage facilities and pump structures required to maintain water pressure for fire suppression^b.

a. For purposes of occupant load calculation, occupancies required by Table 1004.1.1 to use gross floor area calculations shall be permitted to use net floor areas to determine the total occupant load.

b. Not intended for such uses in Categories I, II and III.

**SECTION 1605
LOAD COMBINATIONS**

1605.1 General. Buildings and other structures and portions thereof shall be designed to resist:

1. The load combinations specified in Section 1605.2, 1605.3.1 or 1605.3.2,
2. The load combinations specified in Chapters 18 through 23, and
3. The load combinations with overstrength factor specified in Section 12.4.3.2 of ASCE 7 where required by Section 12.2.5.2, 12.3.3.3 or 12.10.2.1 of ASCE 7. With the simplified procedure of ASCE 7 Section 12.14, the load combinations with overstrength factor of Section 12.14.3.2 of ASCE 7 shall be used.

Applicable loads shall be considered, including both earthquake and wind, in accordance with the specified load combinations. Each load combination shall also be investigated with one or more of the variable loads set to zero.

Where the load combinations with overstrength factor in Section 12.4.3.2 of ASCE 7 apply, they shall be used as follows:

1. The basic combinations for strength design with overstrength factor in lieu of Equations 16-5 and 16-7 in Section 1605.2.1.
2. The basic combinations for *allowable stress design* with overstrength factor in lieu of Equations 16-12, 16-13 and 16-15 in Section 1605.3.1.
3. The basic combinations for *allowable stress design* with overstrength factor in lieu of Equations 16-20 and 16-21 in Section 1605.3.2.

1605.1.1 Stability. Regardless of which load combinations are used to design for strength, where overall structure stability (such as stability against overturning, sliding, or buoyancy) is being verified, use of the load combinations specified in Section 1605.2 or 1605.3 shall be permitted. Where the load combinations specified in Section 1605.2 are used, strength reduction factors applicable to soil resistance shall be provided by a *registered design professional*. The stability of retaining walls shall be verified in accordance with Section 1807.2.3.

1605.2 Load combinations using strength design or load and resistance factor design.

1605.2.1 Basic load combinations. Where strength design or *load and resistance factor design* is used, structures and portions thereof shall resist the most critical effects from the following combinations of factored loads:

$$1.4(D + F) \quad \text{(Equation 16-1)}$$

$$1.2(D + F + T) + 1.6(L + H) + 0.5(L_r \text{ or } S \text{ or } R) \quad \text{(Equation 16-2)}$$

$$1.2D + 1.6(L_r \text{ or } S \text{ or } R) + (f_1L \text{ or } 0.8W) \quad \text{(Equation 16-3)}$$

$$1.2D + 1.6W + f_1L + 0.5(L_r \text{ or } S \text{ or } R) \quad \text{(Equation 16-4)}$$

$$1.2D + 1.0E + f_1L + f_2S \quad \text{(Equation 16-5)}$$

$$0.9D + 1.6W + 1.6H \quad \text{(Equation 16-6)}$$

$$0.9D + 1.0E + 1.6H \quad \text{(Equation 16-7)}$$

where:

$$f_1 = 1 \text{ for floors in places of public assembly, for live loads in excess of 100 pounds per square foot (4.79 kN/m}^2\text{), and for parking garage live load, and} \\ = 0.5 \text{ for other live loads.}$$

$$f_2 = 0.7 \text{ for roof configurations (such as saw tooth) that do not shed snow off the structure, and} \\ = 0.2 \text{ for other roof configurations.}$$

Exception: Where other factored load combinations are specifically required by the provisions of this code, such combinations shall take precedence.

1605.2.2 Flood loads. Where flood loads, F_a , are to be considered in the design, the load combinations of Section 2.3.3 of ASCE 7 shall be used.

1605.3 Load combinations using allowable stress design.

1605.3.1 Basic load combinations. Where *allowable stress design* (working stress design), as permitted by this code, is used, structures and portions thereof shall resist the most critical effects resulting from the following combinations of loads:

$$D + F \quad \text{(Equation 16-8)}$$

$$D + H + F + L + T \quad \text{(Equation 16-9)}$$

$$D + H + F + (L_r \text{ or } S \text{ or } R) \quad \text{(Equation 16-10)}$$

$$D + H + F + 0.75(L + T) + 0.75(L_r \text{ or } S \text{ or } R) \quad \text{(Equation 16-11)}$$

$$D + H + F + (W \text{ or } 0.7E) \quad \text{(Equation 16-12)}$$

$$D + H + F + 0.75(W \text{ or } 0.7E) + 0.75L + 0.75(L_r \text{ or } S \text{ or } R) \quad \text{(Equation 16-13)}$$

$$0.6D + W + H \quad \text{(Equation 16-14)}$$

$$0.6D + 0.7E + H \quad \text{(Equation 16-15)}$$

Exceptions:

1. Crane hook loads need not be combined with roof live load or with more than three-fourths of the snow load or one-half of the wind load.
2. Flat roof snow loads of 30 psf (1.44 kN/m²) or less and roof live loads of 30 psf (1.44 kN/m²) or less need not be combined with seismic loads. Where flat roof snow loads exceed 30 psf (1.44 kN/m²), 20 percent shall be combined with seismic loads.

1605.3.1.1 Stress increases. Increases in allowable stresses specified in the appropriate material chapter or the referenced standards shall not be used with the load combinations of Section 1605.3.1, except that increases shall be permitted in accordance with Chapter 23.

1605.3.1.2 Flood loads. Where flood loads, F_a , are to be considered in design, the load combinations of Section 2.4.2 of ASCE 7 shall be used.

1605.3.2 Alternative basic load combinations. In lieu of the basic load combinations specified in Section 1605.3.1, structures and portions thereof shall be permitted to be designed for the most critical effects resulting from the following combinations. When using these alternative basic load combinations that include wind or seismic loads, allowable stresses are permitted to be increased or load combinations reduced where permitted by the material chapter of this code or the referenced standards. For load combinations that include the counteracting effects of dead and wind loads, only two-thirds of the minimum dead load likely to be in place during a design wind event shall be used. Where wind loads are calculated in accordance with Chapter 6 of ASCE 7, the coefficient ω in the following equations shall be taken as 1.3. For other wind loads, ω shall be taken as 1. When using these alternative load combinations to evaluate sliding, overturning and soil bearing at the soil-structure interface, the reduction of foundation overturning from Section 12.13.4 in ASCE 7 shall not be used. When using these alternative basic load combinations for proportioning foundations for loadings, which include seismic loads, the vertical seismic load effect, E_v , in Equation 12.4-4 of ASCE 7 is permitted to be taken equal to zero.

$$D + L + (L_r \text{ or } S \text{ or } R) \quad \text{(Equation 16-16)}$$

$$D + L + (\omega W) \quad \text{(Equation 16-17)}$$

$$D + L + \omega W + S/2 \quad \text{(Equation 16-18)}$$

$$D + L + S + \omega W/2 \quad \text{(Equation 16-19)}$$

$$D + L + S + E/1.4 \quad \text{(Equation 16-20)}$$

$$0.9D + E/1.4 \quad \text{(Equation 16-21)}$$

Exceptions:

1. Crane hook loads need not be combined with roof live loads or with more than three-fourths of the snow load or one-half of the wind load.
2. Flat roof snow loads of 30 psf (1.44 kN/m²) or less and roof live loads of 30 psf (1.44 kN/m²) or less need not be combined with seismic loads. Where flat roof snow loads exceed 30 psf (1.44 kN/m²), 20 percent shall be combined with seismic loads.

1605.3.2.1 Other loads. Where F , H or T are to be considered in the design, each applicable load shall be added to the combinations specified in Section 1605.3.2.

1605.4 Heliports and helistops. Heliport and helistop landing areas shall be designed for the following loads, combined in accordance with Section 1605:

1. Dead load, D , plus the gross weight of the helicopter, D_h , plus snow load, S .
2. Dead load, D , plus two single concentrated impact loads, L , approximately 8 feet (2438 mm) apart applied anywhere on the touchdown pad (representing each of the helicopter's two main landing gear, whether skid type or wheeled type), having a magnitude of 0.75 times the gross weight of the helicopter. Both loads acting together total 1.5 times the gross weight of the helicopter.

3. Dead load, D , plus a uniform live load, L , of 100 psf (4.79 kN/m²).

Exception: Landing areas designed for helicopters with gross weights not exceeding 3,000 pounds (13.34 kN) in accordance with Items 1 and 2 shall be permitted to be designed using a 40 psf (1.92 kN/m²) uniform live load in Item 3, provided the landing area is identified with a 3,000-pound (13.34 kN) weight limitation. This 40-psf (1.92 kN/m²) uniform live load shall not be reduced. The landing area weight limitation shall be indicated by the numeral "3" (kips) located in the bottom right corner of the landing area as viewed from the primary approach path. The indication for the landing area weight limitation shall be a minimum 5 feet (1524 mm) in height.

SECTION 1606 DEAD LOADS

1606.1 General. Dead loads are those loads defined in Section 1602.1. Dead loads shall be considered permanent loads.

1606.2 Design dead load. For purposes of design, the actual weights of materials of construction and fixed service equipment shall be used. In the absence of definite information, values used shall be subject to the approval of the *building official*.

SECTION 1607 LIVE LOADS

1607.1 General. Live loads are those loads defined in Section 1602.1.

1607.2 Loads not specified. For occupancies or uses not designated in Table 1607.1, the live load shall be determined in accordance with a method *approved* by the *building official*.

1607.3 Uniform live loads. The live loads used in the design of buildings and other structures shall be the maximum loads expected by the intended use or occupancy but shall in no case be less than the minimum uniformly distributed unit loads required by Table 1607.1.

1607.4 Concentrated loads. Floors and other similar surfaces shall be designed to support the uniformly distributed live loads prescribed in Section 1607.3 or the concentrated load, in pounds (kilonewtons), given in Table 1607.1, whichever produces the greater *load effects*. Unless otherwise specified, the indicated concentration shall be assumed to be uniformly distributed over an area 2½ feet by 2½ feet (0.76 m by 0.76 m) [6¼ square feet (0.58 m²)] and shall be located so as to produce the maximum *load effects* in the structural members.

1607.5 Partition loads. In office buildings and in other buildings where partition locations are subject to change, provisions for partition weight shall be made, whether or not partitions are shown on the *construction documents*, unless the specified live load exceeds 80 psf (3.83 kN/m²). The partition load shall not be less than a uniformly distributed live load of 15 psf (0.72 kN/m²).

TABLE 1607.1
MINIMUM UNIFORMLY DISTRIBUTED LIVE LOADS, L_o , AND
MINIMUM CONCENTRATED LIVE LOADS⁹

OCCUPANCY OR USE	UNIFORM (psf)	CONCENTRATED (lbs.)
1. Apartments (see residential)	—	—
2. Access floor systems		
Office use	50	2,000
Computer use	100	2,000
3. Armories and drill rooms	150	—
4. Assembly areas and theaters		
Fixed seats (fastened to floor)	60	
Follow spot, projections and control rooms	50	—
Lobbies	100	
Movable seats	100	
Stages and platforms	125	
Other assembly areas	100	
5. Balconies (exterior) and decks ^h	Same as occupancy served	—
6. Bowling alleys	75	—
7. Catwalks	40	300
8. Cornices	60	—
9. Corridors, except as otherwise indicated	100	—
10. Dance halls and ballrooms	100	—
11. Dining rooms and restaurants	100	—
12. Dwellings (see residential)	—	—
13. Elevator machine room grating (on area of 4 in ²)	—	300
14. Finish light floor plate construction (on area of 1 in ²)	—	200
15. Fire escapes	100	—
On single-family dwellings only	40	—
16. Garages (passenger vehicles only)	40	Note a
Trucks and buses	See Section 1607.6	
17. Grandstands (see stadium and arena bleachers)	—	—
18. Gymnasiums, main floors and balconies	100	—
19. Handrails, guards and grab bars	See Section 1607.7	
20. Hospitals		
Corridors above first floor	80	1,000
Operating rooms, laboratories	60	1,000
Patient rooms	40	1,000
21. Hotels (see residential)	—	—
22. Libraries		
Corridors above first floor	80	1,000
Reading rooms	60	1,000
Stack rooms	150 ^b	1,000

continued

TABLE 1607.1—continued
MINIMUM UNIFORMLY DISTRIBUTED LIVE LOADS, L_o , AND
MINIMUM CONCENTRATED LIVE LOADS⁹

OCCUPANCY OR USE	UNIFORM (psf)	CONCENTRATED (lbs.)
23. Manufacturing		
Heavy	250	3,000
Light	125	2,000
24. Marquees	75	—
25. Office buildings		
Corridors above first floor	80	2,000
File and computer rooms shall be designed for heavier loads based on anticipated occupancy	—	—
Lobbies and first-floor corridors	100	2,000
Offices	50	2,000
26. Penal institutions		
Cell blocks	40	—
Corridors	100	—
27. Residential		
One- and two-family dwellings		
Uninhabitable attics without storage ⁱ	10	
Uninhabitable attics with limited storage ^{i, j, k}	20	
Habitable attics and sleeping areas	30	—
All other areas	40	
Hotels and multifamily dwellings		
Private rooms and corridors serving them	40	
Public rooms and corridors serving them	100	
28. Reviewing stands, grandstands and bleachers	Note c	
29. Roofs		
All roof surfaces subject to maintenance workers		300
Awnings and canopies		
Fabric construction supported by a lightweight rigid skeleton structure	5 nonreducible	
All other construction	20	
Ordinary flat, pitched, and curved roofs	20	
Primary roof members, exposed to a work floor		
Single panel point of lower chord of roof trusses or any point along primary structural members supporting roofs:		
Over manufacturing, storage warehouses, and repair garages		2,000
All other occupancies		300
Roofs used for other special purposes	Note 1	Note 1
Roofs used for promenade purposes	60	
Roofs used for roof gardens or assembly purposes	100	
30. Schools		
Classrooms	40	1,000
Corridors above first floor	80	1,000
First-floor corridors	100	1,000
31. Scuttles, skylight ribs and accessible ceilings	—	200
32. Sidewalks, vehicular driveways and yards, subject to trucking	250 ^d	8,000 ^e
33. Skating rinks	100	—

continued

TABLE 1607.1—continued
MINIMUM UNIFORMLY DISTRIBUTED LIVE LOADS, L_o , AND
MINIMUM CONCENTRATED LIVE LOADS^g

OCCUPANCY OR USE	UNIFORM (psf)	CONCENTRATED (lbs.)
34. Stadiums and arenas Bleachers Fixed seats (fastened to floor)	100 ^c 60 ^c	—
35. Stairs and exits One- and two-family dwellings All other	40 100	Note f
36. Storage warehouses (shall be designed for heavier loads if required for anticipated storage) Heavy Light	250 125	
37. Stores Retail First floor Upper floors Wholesale, all floors	100 75 125	1,000 1,000 1,000
38. Vehicle barrier systems	See Section 1607.7.3	
39. Walkways and elevated platforms (other than exitways)	60	—
40. Yards and terraces, pedestrians	100	—

For SI: 1 inch = 25.4 mm, 1 foot = 304.8 mm, 1 square inch = 645.16 mm²,
 1 square foot = 0.0929 m²,
 1 pound per square foot = 0.0479 kN/m², 1 pound = 0.004448 kN,

- a. Floors in garages or portions of buildings used for the storage of motor vehicles shall be designed for the uniformly distributed live loads of Table 1607.1 or the following concentrated loads: (1) for garages restricted to passenger vehicles accommodating not more than nine passengers, 3,000 pounds acting on an area of 4.5 inches by 4.5 inches; (2) for mechanical parking structures without slab or deck which are used for storing passenger vehicles only, 2,250 pounds per wheel.
- b. The loading applies to stack room floors that support nonmobile, double-faced library bookstacks, subject to the following limitations:
 - 1. The nominal bookstack unit height shall not exceed 90 inches;
 - 2. The nominal shelf depth shall not exceed 12 inches for each face; and
 - 3. Parallel rows of double-faced bookstacks shall be separated by aisles not less than 36 inches wide.
- c. Design in accordance with ICC 300.
- d. Other uniform loads in accordance with an approved method which contains provisions for truck loadings shall also be considered where appropriate.
- e. The concentrated wheel load shall be applied on an area of 4.5 inches by 4.5 inches.
- f. Minimum concentrated load on stair treads (on area of 4 square inches) is 300 pounds.
- g. Where snow loads occur that are in excess of the design conditions, the structure shall be designed to support the loads due to the increased loads caused by drift buildup or a greater snow design determined by the building official (see Section 1608). For special-purpose roofs, see Section 1607.11.2.2.
- h. See Section 1604.8.3 for decks attached to exterior walls.
- i. Attics without storage are those where the maximum clear height between the joist and rafter is less than 42 inches, or where there are not two or more adjacent trusses with the same web configuration capable of containing a rectangle 42 inches high by 2 feet wide, or greater, located within the plane of the truss. For attics without storage, this live load need not be assumed to act concurrently with any other live load requirements.
- j. For attics with limited storage and constructed with trusses, this live load need only be applied to those portions of the bottom chord where there are two or more adjacent trusses with the same web configuration capable of containing a rectangle 42 inches high by 2 feet wide or greater, located within the plane of the truss. The rectangle shall fit between the top of the bottom chord and the bottom of any other truss member, provided that each of the following criteria is met:
 - i. The attic area is accessible by a pull-down stairway or framed opening in accordance with Section 1209.2, and
 - ii. The truss shall have a bottom chord pitch less than 2:12.
 - iii. Bottom chords of trusses shall be designed for the greater of actual imposed dead load or 10 psf, uniformly distributed over the entire span.
- k. Attic spaces served by a fixed stair shall be designed to support the minimum live load specified for habitable attics and sleeping rooms.
- l. Roofs used for other special purposes shall be designed for appropriate loads as approved by the building official.

1607.6 Truck and bus garages. Minimum live loads for garages having trucks or buses shall be as specified in Table 1607.6, but shall not be less than 50 psf (2.40 kN/m²), unless other loads are specifically justified and *approved* by the *building official*. Actual loads shall be used where they are greater than the loads specified in the table.

1607.6.1 Truck and bus garage live load application. The concentrated load and uniform load shall be uniformly distributed over a 10-foot (3048 mm) width on a line normal to the centerline of the lane placed within a 12-foot-wide (3658 mm) lane. The loads shall be placed within their individual lanes so as to produce the maximum stress in each structural member. Single spans shall be designed for the uniform load in Table 1607.6 and one simultaneous concentrated load positioned to produce the maximum effect. Multiple spans shall be designed for the uniform load in Table 1607.6 on the spans and two simultaneous concentrated loads in two spans positioned to produce the maximum negative moment effect. Multiple span design loads, for other effects, shall be the same as for single spans.

TABLE 1607.6
UNIFORM AND CONCENTRATED LOADS

LOADING CLASS ^a	UNIFORM LOAD (pounds/linear foot of lane)	CONCENTRATED LOAD (pounds) ^b	
		For moment design	For shear design
H20-44 and HS20-44	640	18,000	26,000
H15-44 and HS15-44	480	13,500	19,500

For SI: 1 pound per linear foot = 0.01459 kN/m, 1 pound = 0.004448 kN, 1 ton = 8.90 kN.

- a. An H loading class designates a two-axle truck with a semitrailer. An HS loading class designates a tractor truck with a semitrailer. The numbers following the letter classification indicate the gross weight in tons of the standard truck and the year the loadings were instituted.
- b. See Section 1607.6.1 for the loading of multiple spans.

1607.7 Loads on handrails, guards, grab bars, seats and vehicle barrier systems. Handrails, *guards*, grab bars, accessible seats, accessible benches and vehicle barrier systems shall be designed and constructed to the structural loading conditions set forth in this section.

1607.7.1 Handrails and guards. Handrails and *guards* shall be designed to resist a load of 50 pounds per linear foot (plf) (0.73 kN/m) applied in any direction at the top and to transfer this load through the supports to the structure. Glass handrail assemblies and *guards* shall also comply with Section 2407.

Exceptions:

- 1. For one- and two-family dwellings, only the single concentrated load required by Section 1607.7.1.1 shall be applied.
- 2. In Group I-3, F, H and S occupancies, for areas that are not accessible to the general public and that have an *occupant load* less than 50, the minimum load shall be 20 pounds per foot (0.29 kN/m).

1607.7.1.1 Concentrated load. Handrails and *guards* shall be able to resist a single concentrated load of 200 pounds (0.89 kN), applied in any direction at any point

along the top, and to transfer this load through the supports to the structure. This load need not be assumed to act concurrently with the loads specified in Section 1607.7.1.

1607.7.1.2 Components. Intermediate rails (all those except the handrail), balusters and panel fillers shall be designed to withstand a horizontally applied normal load of 50 pounds (0.22 kN) on an area equal to 1 square foot (0.0929 m²), including openings and space between rails. Reactions due to this loading are not required to be superimposed with those of Section 1607.7.1 or 1607.7.1.1.

1607.7.2 Grab bars, shower seats and dressing room bench seats. Grab bars, shower seats and dressing room bench seat systems shall be designed to resist a single concentrated load of 250 pounds (1.11 kN) applied in any direction at any point.

1607.7.3 Vehicle barrier systems. Vehicle barrier systems for passenger vehicles shall be designed to resist a single load of 6,000 pounds (26.70 kN) applied horizontally in any direction to the barrier system and shall have anchorage or attachment capable of transmitting this load to the structure. For design of the system, two loading conditions shall be analyzed. The first condition shall apply the load at a height of 1 foot, 6 inches (457 mm) above the floor or ramp surface. The second loading condition shall apply the load at 2 feet, 3 inches (686 mm) above the floor or ramp surface. The more severe load condition shall govern the design of the barrier restraint system. The load shall be assumed to act on an area not to exceed 1 square foot (0.0929 m²), and is not required to be assumed to act concurrently with any handrail or *guard* loadings specified in Section 1607.7.1. Garages accommodating trucks and buses shall be designed in accordance with an *approved* method that contains provisions for traffic railings.

1607.8 Impact loads. The live loads specified in Section 1607.3 include allowance for impact conditions. Provisions shall be made in the structural design for uses and loads that involve unusual vibration and impact forces.

1607.8.1 Elevators. Elevator loads shall be increased by 100 percent for impact and the structural supports shall be designed within the limits of deflection prescribed by ASME A17.1.

1607.8.2 Machinery. For the purpose of design, the weight of machinery and moving loads shall be increased as follows to allow for impact: (1) elevator machinery, 100 percent; (2) light machinery, shaft- or motor-driven, 20 percent; (3) reciprocating machinery or power-driven units, 50 percent; (4) hangers for floors or balconies, 33 percent. Percentages shall be increased where specified by the manufacturer.

1607.9 Reduction in live loads. Except for uniform live loads at roofs, all other minimum uniformly distributed live loads, L_o , in Table 1607.1 are permitted to be reduced in accordance with Section 1607.9.1 or 1607.9.2. Roof uniform live loads, other than special purpose roofs of Section 1607.11.2.2, are permitted

to be reduced in accordance with Section 1607.11.2. Roof uniform live loads of special purpose roofs are permitted to be reduced in accordance with Section 1607.9.1 or 1607.9.2.

1607.9.1 General. Subject to the limitations of Sections 1607.9.1.1 through 1607.9.1.4, members for which a value of $K_{LL}A_T$ is 400 square feet (37.16 m²) or more are permitted to be designed for a reduced live load in accordance with the following equation:

$$L = L_o \left(0.25 + \frac{15}{\sqrt{K_{LL} A_T}} \right) \quad \text{(Equation 16-22)}$$

For SI: $L = L_o \left(0.25 + \frac{4.57}{\sqrt{K_{LL} A_T}} \right)$

where:

L = Reduced design live load per square foot (square meter) of area supported by the member.

L_o = Unreduced design live load per square foot (square meter) of area supported by the member (see Table 1607.1).

K_{LL} = Live load element factor (see Table 1607.9.1).

A_T = Tributary area, in square feet (square meters).

L shall not be less than $0.50L_o$ for members supporting one floor and L shall not be less than $0.40L_o$ for members supporting two or more floors.

**TABLE 1607.9.1
LIVE LOAD ELEMENT FACTOR, K_{LL}**

ELEMENT	K_{LL}
Interior columns	4
Exterior columns without cantilever slabs	4
Edge columns with cantilever slabs	3
Corner columns with cantilever slabs	2
Edge beams without cantilever slabs	2
Interior beams	2
All other members not identified above including: Edge beams with cantilever slabs Cantilever beams One-way slabs Two-way slabs Members without provisions for continuous shear transfer normal to their span	1

1607.9.1.1 One-way slabs. The tributary area, A_T , for use in Equation 16-22 for one-way slabs shall not exceed an area defined by the slab span times a width normal to the span of 1.5 times the slab span.

1607.9.1.2 Heavy live loads. Live loads that exceed 100 psf (4.79 kN/m²) shall not be reduced.

Exceptions:

1. The live loads for members supporting two or more floors are permitted to be reduced by a maximum of 20 percent, but the live load shall

not be less than L as calculated in Section 1607.9.1.

- For uses other than storage, where *approved*, additional live load reductions shall be permitted where shown by the *registered design professional* that a rational approach has been used and that such reductions are warranted.

1607.9.1.3 Passenger vehicle garages. The live loads shall not be reduced in passenger vehicle garages.

Exception: The live loads for members supporting two or more floors are permitted to be reduced by a maximum of 20 percent, but the live load shall not be less than L as calculated in Section 1607.9.1.

1607.9.1.4 Group A occupancies. Live loads of 100 psf (4.79 kN/m²) and at areas where fixed seats are located shall not be reduced in Group A occupancies.

1607.9.1.5 Roof members. Live loads of 100 psf (4.79 kN/m²) or less shall not be reduced for roof members except as specified in Section 1607.11.2.

1607.9.2 Alternate floor live load reduction. As an alternative to Section 1607.9.1, floor live loads are permitted to be reduced in accordance with the following provisions. Such reductions shall apply to slab systems, beams, girders, columns, piers, walls and foundations.

- A reduction shall not be permitted in Group A occupancies.
- A reduction shall not be permitted where the live load exceeds 100 psf (4.79 kN/m²) except that the design live load for members supporting two or more floors is permitted to be reduced by 20 percent.

Exception: For uses other than storage, where *approved*, additional live load reductions shall be permitted where shown by the *registered design professional* that a rational approach has been used and that such reductions are warranted.

- A reduction shall not be permitted in passenger vehicle parking garages except that the live loads for members supporting two or more floors are permitted to be reduced by a maximum of 20 percent.
- For live loads not exceeding 100 psf (4.79 kN/m²), the design live load for any structural member supporting 150 square feet (13.94 m²) or more is permitted to be reduced in accordance with Equation 16-23.
- For one-way slabs, the area, A , for use in Equation 16-23 shall not exceed the product of the slab span and a width normal to the span of 0.5 times the slab span.

$$R = 0.08(A - 150) \quad (\text{Equation 16-23})$$

For SI: $R = 0.861(A - 13.94)$

Such reduction shall not exceed the smallest of:

- 40 percent for horizontal members;
- 60 percent for vertical members; or
- R as determined by the following equation.

$$R = 23.1(1 + D/L_o) \quad (\text{Equation 16-24})$$

where:

A = Area of floor supported by the member, square feet (m²).

D = Dead load per square foot (m²) of area supported.

L_o = Unreduced live load per square foot (m²) of area supported.

R = Reduction in percent.

1607.10 Distribution of floor loads. Where uniform floor live loads are involved in the design of structural members arranged so as to create continuity, the minimum applied loads shall be the full dead loads on all spans in combination with the floor live loads on spans selected to produce the greatest effect at each location under consideration. It shall be permitted to reduce floor live loads in accordance with Section 1607.9.

1607.11 Roof loads. The structural supports of roofs and marquees shall be designed to resist wind and, where applicable, snow and earthquake loads, in addition to the dead load of construction and the appropriate live loads as prescribed in this section, or as set forth in Table 1607.1. The live loads acting on a sloping surface shall be assumed to act vertically on the horizontal projection of that surface.

1607.11.1 Distribution of roof loads. Where uniform roof live loads are reduced to less than 20 psf (0.96 kN/m²) in accordance with Section 1607.11.2.1 and are applied to the design of structural members arranged so as to create continuity, the reduced roof live load shall be applied to adjacent spans or to alternate spans, whichever produces the most unfavorable *load effect*. See Section 1607.11.2 for reductions in minimum roof live loads and Section 7.5 of ASCE 7 for partial snow loading.

1607.11.2 Reduction in roof live loads. The minimum uniformly distributed live loads of roofs and marquees, L_o , in Table 1607.1 are permitted to be reduced in accordance with Section 1607.11.2.1 or 1607.11.2.2.

1607.11.2.1 Flat, pitched and curved roofs. Ordinary flat, pitched and curved roofs, and awnings and canopies other than of fabric construction supported by lightweight rigid skeleton structures, are permitted to be designed for a reduced roof live load as specified in the following equations or other controlling combinations of loads in Section 1605, whichever produces the greater load.

In structures such as greenhouses, where special scaffolding is used as a work surface for workers and materials during maintenance and repair operations, a lower roof load than specified in the following equations shall not be used unless *approved* by the *building official*. Such structures shall be designed for a minimum roof live load of 12 psf (0.58 kN/m²).

$$L_r = L_o R_1 R_2 \quad (\text{Equation 16-25})$$

where: $12 \leq L_r \leq 20$

For SI: $L_r = L_o R_1 R_2$

where: $0.58 \leq L_r \leq 0.96$

L_r = Reduced live load per square foot (m²) of horizontal projection in pounds per square foot (kN/m²).

The reduction factors R_1 and R_2 shall be determined as follows:

$R_1 = 1$ for $A_t \leq 200$ square feet
(18.58 m²) (Equation 16-26)

$R_1 = 1.2 - 0.001A_t$ for 200 square feet $< A_t < 600$ square feet (Equation 16-27)

For SI: $1.2 - 0.011A_t$ for 18.58 square meters $< A_t < 55.74$ square meters

$R_1 = 0.6$ for $A_t \geq 600$ square feet
(55.74 m²) (Equation 16-28)

where:

A_t = Tributary area (span length multiplied by effective width) in square feet (m²) supported by any structural member, and

$R_2 = 1$ for $F \leq 4$ (Equation 16-29)

$R_2 = 1.2 - 0.05 F$ for $4 < F < 12$ (Equation 16-30)

$R_2 = 0.6$ for $F \geq 12$ (Equation 16-31)

where:

F = For a sloped roof, the number of inches of rise per foot (for SI: $F = 0.12 \times$ slope, with slope expressed as a percentage), or for an arch or dome, the rise-to-span ratio multiplied by 32.

1607.11.2.2 Special-purpose roofs. Roofs used for promenade purposes, roof gardens, assembly purposes or other special purposes, and marquees, shall be designed for a minimum live load, L_o , as specified in Table 1607.1. Such live loads are permitted to be reduced in accordance with Section 1607.9. Live loads of 100 psf (4.79 kN/m²) or more at areas of roofs classified as Group A occupancies shall not be reduced.

1607.11.3 Landscaped roofs. Where roofs are to be landscaped, the uniform design live load in the landscaped area shall be 20 psf (0.958 kN/m²). The weight of the landscaping materials shall be considered as dead load and shall be computed on the basis of saturation of the soil.

1607.11.4 Awnings and canopies. Awnings and canopies shall be designed for uniform live loads as required in Table 1607.1 as well as for snow loads and wind loads as specified in Sections 1608 and 1609.

1607.12 Crane loads. The crane live load shall be the rated capacity of the crane. Design loads for the runway beams, including connections and support brackets, of moving bridge cranes and monorail cranes shall include the maximum wheel

loads of the crane and the vertical impact, lateral and longitudinal forces induced by the moving crane.

1607.12.1 Maximum wheel load. The maximum wheel loads shall be the wheel loads produced by the weight of the bridge, as applicable, plus the sum of the rated capacity and the weight of the trolley with the trolley positioned on its runway at the location where the resulting load effect is maximum.

1607.12.2 Vertical impact force. The maximum wheel loads of the crane shall be increased by the percentages shown below to determine the induced vertical impact or vibration force:

Monorail cranes (powered)	25 percent
Cab-operated or remotely operated bridge cranes (powered)	25 percent
Pendant-operated bridge cranes (powered)	10 percent
Bridge cranes or monorail cranes with hand-gear bridge, trolley and hoist	0 percent

1607.12.3 Lateral force. The lateral force on crane runway beams with electrically powered trolleys shall be calculated as 20 percent of the sum of the rated capacity of the crane and the weight of the hoist and trolley. The lateral force shall be assumed to act horizontally at the traction surface of a runway beam, in either direction perpendicular to the beam, and shall be distributed according to the lateral stiffness of the runway beam and supporting structure.

1607.12.4 Longitudinal force. The longitudinal force on crane runway beams, except for bridge cranes with hand-gear bridges, shall be calculated as 10 percent of the maximum wheel loads of the crane. The longitudinal force shall be assumed to act horizontally at the traction surface of a runway beam, in either direction parallel to the beam.

1607.13 Interior walls and partitions. Interior walls and partitions that exceed 6 feet (1829 mm) in height, including their finish materials, shall have adequate strength to resist the loads to which they are subjected but not less than a horizontal load of 5 psf (0.240 kN/m²).

Exception: Fabric partitions complying with Section 1607.13.1 shall not be required to resist the minimum horizontal load of 5 psf (0.24 kN/m²).

1607.13.1 Fabric partitions. Fabric partitions that exceed 6 feet (1829 mm) in height, including their finish materials, shall have adequate strength to resist the following load conditions:

1. A horizontal distributed load of 5 psf (0.24 kN/m²) applied to the partition framing. The total area used to determine the distributed load shall be the area of the fabric face between the framing members to which the fabric is attached. The total distributed load shall be uniformly applied to such framing members in proportion to the length of each member.

2. A concentrated load of 40 pounds (0.176 kN) applied to an 8-inch diameter (203 mm) area [50.3 square inches (32 452 mm²)] of the fabric face at a height of 54 inches (1372 mm) above the floor.

SECTION 1608 SNOW LOADS

1608.1 General. Design snow loads shall be determined in accordance with Chapter 7 of ASCE 7, but the design roof load shall not be less than that determined by Section 1607.

1608.2 Ground snow loads. The ground snow loads to be used in determining the design snow loads for roofs shall be determined in accordance with ASCE 7 or Figure 1608.2 for North Carolina. Site-specific case studies shall be made in areas designated “CS” in Figure 1608.2. Ground snow loads for sites at elevations above the limits indicated in Figure 1608.2 and for all sites within the CS areas shall be *approved*. Ground snow load determination for such sites shall be based on an extreme value statistical analysis of data available in the vicinity of the site using a value with a 2-percent annual probability of being exceeded (50-year mean recurrence interval).

SECTION 1609 WIND LOADS

1609.1 Applications. Buildings, structures and parts thereof shall be designed to withstand the minimum wind loads prescribed herein. Decreases in wind loads shall not be made for the effect of shielding by other structures.

1609.1.1 Determination of wind loads. Wind loads on every building or structure shall be determined in accordance with Chapter 6 of ASCE 7 or provisions of the alternate all-heights method in Section 1609.6. The type of opening protection required, the basic wind speed and the exposure category for a site is permitted to be determined in accordance with Section 1609 or ASCE 7. Wind shall be assumed to come from any horizontal direction and wind pressures shall be assumed to act normal to the surface considered.

Exceptions:

1. Subject to the limitations of Section 1609.1.1.1, the provisions of ICC 600 shall be permitted for applicable Group R-2 and R-3 buildings.
2. Subject to the limitations of Section 1609.1.1.1, residential structures using the provisions of the AF&PA WFCM.
3. Subject to the limitations of Section 1609.1.1.1, residential structures using the provisions of AISI S230.
4. Designs using NAAMM FP 1001.
5. Designs using TIA-222 for antenna-supporting structures and antennas.

6. Wind tunnel tests in accordance with Section 6.6 of ASCE 7, subject to the limitations in Section 1609.1.1.2.

1609.1.1.1 Applicability. The provisions of ICC 600 are applicable only to buildings located within Exposure B or C as defined in Section 1609.4. The provisions of ICC 600, AF&PA WFCM and AISI S230 shall not apply to buildings sited on the upper half of an isolated hill, ridge or escarpment meeting the following conditions:

1. The hill, ridge or escarpment is 60 feet (18 288 mm) or higher if located in Exposure B or 30 feet (9144 mm) or higher if located in Exposure C;
2. The maximum average slope of the hill exceeds 10 percent; and
3. The hill, ridge or escarpment is unobstructed upwind by other such topographic features for a distance from the high point of 50 times the height of the hill or 1 mile (1.61 km), whichever is greater.

1609.1.1.2 Wind tunnel test limitations. The lower limit on pressures for main wind-force-resisting systems and components and cladding shall be in accordance with Sections 1609.1.1.2.1 and 1609.1.1.2.2.

1609.1.1.2.1 Lower limits on main wind-force-resisting system. Base overturning moments determined from wind tunnel testing shall be limited to not less than 80 percent of the design base overturning moments determined in accordance with Section 6.5 of ASCE 7, unless specific testing is performed that demonstrates it is the aerodynamic coefficient of the building, rather than shielding from other structures, that is responsible for the lower values. The 80-percent limit shall be permitted to be adjusted by the ratio of the frame load at critical wind directions as determined from wind tunnel testing without specific adjacent buildings, but including appropriate upwind roughness, to that determined in Section 6.5 of ASCE 7.

1609.1.1.2.2 Lower limits on components and cladding. The design pressures for components and cladding on walls or roofs shall be selected as the greater of the wind tunnel test results or 80 percent of the pressure obtained for Zone 4 for walls and Zone 1 for roofs as determined in Section 6.5 of ASCE 7, unless specific testing is performed that demonstrates it is the aerodynamic coefficient of the building, rather than shielding from nearby structures, that is responsible for the lower values. Alternatively, limited tests at a few wind directions without specific adjacent buildings, but in the presence of an appropriate upwind roughness, shall be permitted to be used to demonstrate that the lower pressures are due to the shape of the building and not to shielding.



FIGURE 1608.2—continued
GROUND SNOW LOADS, p_g , FOR THE UNITED STATES (psf)

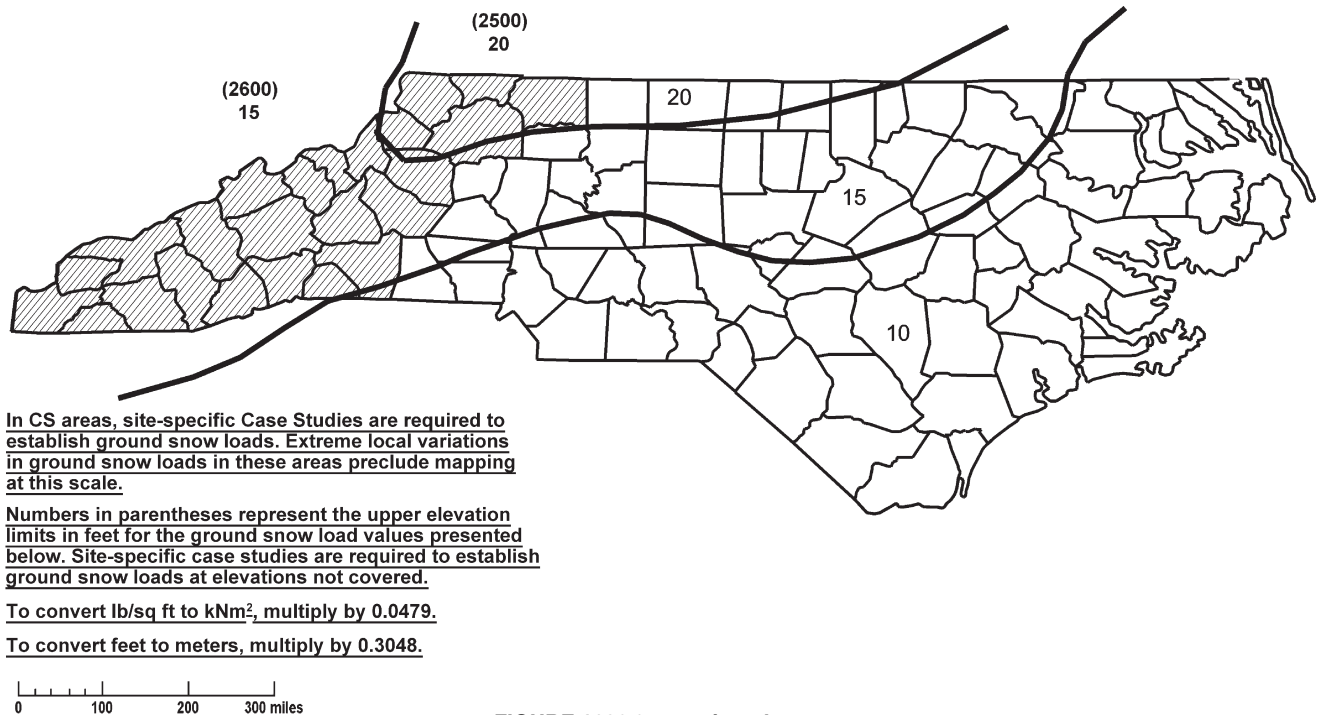

In CS areas, site-specific Case Studies are required to establish ground snow loads. Extreme local variations in ground snow loads in these areas preclude mapping at this scale.

Numbers in parentheses represent the upper elevation limits in feet for the ground snow load values presented below. Site-specific case studies are required to establish ground snow loads at elevations not covered.

To convert lb/sq ft to kNm², multiply by 0.0479.

To convert feet to meters, multiply by 0.3048.

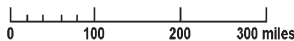

FIGURE 1608.2—continued
GROUND SNOW LOADS, *P_g*, FOR THE STATE OF NORTH CAROLINA (psf)

1609.1.2 Protection of openings. In *wind-borne debris regions*, glazing in buildings shall be impact resistant or protected with an impact-resistant covering meeting the requirements of an *approved* impact-resistant standard or ASTM E 1996 and ASTM E 1886 referenced herein as follows:

1. Glazed openings located within 30 feet (9144 mm) of grade shall meet the requirements of the large missile test of ASTM E 1996.
2. Glazed openings located more than 30 feet (9144 mm) above grade shall meet the provisions of the small missile test of ASTM E 1996.

Exceptions:

1. Wood structural panels with a minimum thickness of $\frac{7}{16}$ inch (11.1mm) and maximum panel span of 8 feet (2438 mm) shall be permitted for opening protection in buildings with a mean roof height of 45 feet (13 716 mm) or less. Panels shall be precut so that they shall be attached to the framing surrounding the opening containing the product with the glazed opening. Panels shall be secured with the attachment hardware provided. Attachments shall be designed to resist the components and cladding loads determined in accordance with the provisions of ASCE 7. Attachment in accordance

with Table 1609.1.2 is permitted for buildings with a mean roof height of 45 feet (13 716 mm) or less where wind speeds do not exceed 140 mph (63 m/s).

2. Glazing in *Occupancy Category I* buildings as defined in Section 1604.5, including greenhouses that are occupied for growing plants on a production or research basis, without public access shall be permitted to be unprotected.
3. Glazing in *Occupancy Category II, III or IV* buildings located over 60 feet (18 288 mm) above the ground and over 30 feet (9144 mm) above aggregate surfaced (stone ballast or gravel) roofs located within 1,500 feet (458 m) of the building shall be permitted to be unprotected.

1609.1.2.1 Louvers. Operable louvers protecting intake and exhaust ventilation ducts not assumed to be open that are located within 30 feet (9144 mm) of grade shall meet requirements of an *approved* impact-resisting standard or the large missile test of ASTM E 1996.

1609.1.2.2 Garage doors. Garage door glazed opening protection for wind-borne debris shall meet the requirements of an *approved* impact-resisting standard or ANSI/DASMA 115.

1609.2 Definitions. The following words and terms shall, for the purposes of Section 1609, have the meanings shown herein.

TABLE 1609.1.2
WIND-BORNE DEBRIS PROTECTION FASTENING
SCHEDULE FOR WOOD STRUCTURAL PANELS^{a, b, c, d}

FASTENER TYPE	FASTENER SPACING (inches)		
	Panel Span ≤ 4 feet	4 feet < Panel Span ≤ 6 feet	6 feet < Panel Span ≤ 8 feet
No. 8 wood-screw-based anchor with 2-inch embedment length	16	10	8
No. 10 wood-screw-based anchor with 2-inch embedment length	16	12	9
1/4-inch diameter lag-screw-based anchor with 2-inch embedment length	16	16	16

For SI: 1 inch = 25.4 mm, 1 foot = 304.8 mm, 1 pound = 4.448 N, 1 mile per hour = 0.447 m/s.

- This table is based on 140 mph wind speeds and a 45-foot mean roof height.
- Fasteners shall be installed at opposing ends of the wood structural panel. Fasteners shall be located a minimum of 1 inch from the edge of the panel.
- Anchors shall penetrate through the exterior wall covering with an embedment length of 2 inches minimum into the building frame. Fasteners shall be located a minimum of 2 1/2 inches from the edge of concrete block or concrete.
- Where panels are attached to masonry or masonry/stucco, they shall be attached using vibration-resistant anchors having a minimum ultimate withdrawal capacity of 1,500 pounds.

HURRICANE-PRONE REGIONS. Areas vulnerable to hurricanes defined as:

- The U. S. Atlantic Ocean and Gulf of Mexico coasts where the basic wind speed is greater than 90 mph (40 m/s) and
- Hawaii, Puerto Rico, Guam, Virgin Islands and American Samoa.

WIND-BORNE DEBRIS REGION. Areas within hurricane-prone regions defined as that area east of the inland waterway from the North Carolina/South Carolina state line north to Beaufort Inlet and from that point to include the barrier islands to the North Carolina/Virginia state line.

1609.3 Basic wind speed. The basic wind speed, in mph, for the determination of the wind loads shall be determined by Figure 1609. Basic wind speed for the special wind regions indicated, near mountainous terrain and near gorges shall be in accordance with local jurisdiction requirements. Basic wind speeds determined by the local jurisdiction shall be in accordance with Section 6.5.4 of ASCE 7.

In nonhurricane-prone regions, when the basic wind speed is estimated from regional climatic data, the basic wind speed shall be not less than the wind speed associated with an annual probability of 0.02 (50-year mean recurrence interval), and the estimate shall be adjusted for equivalence to a 3-second gust wind speed at 33 feet (10 m) above ground in Exposure Category C. The data analysis shall be performed in accordance with Section 6.5.4.2 of ASCE 7.

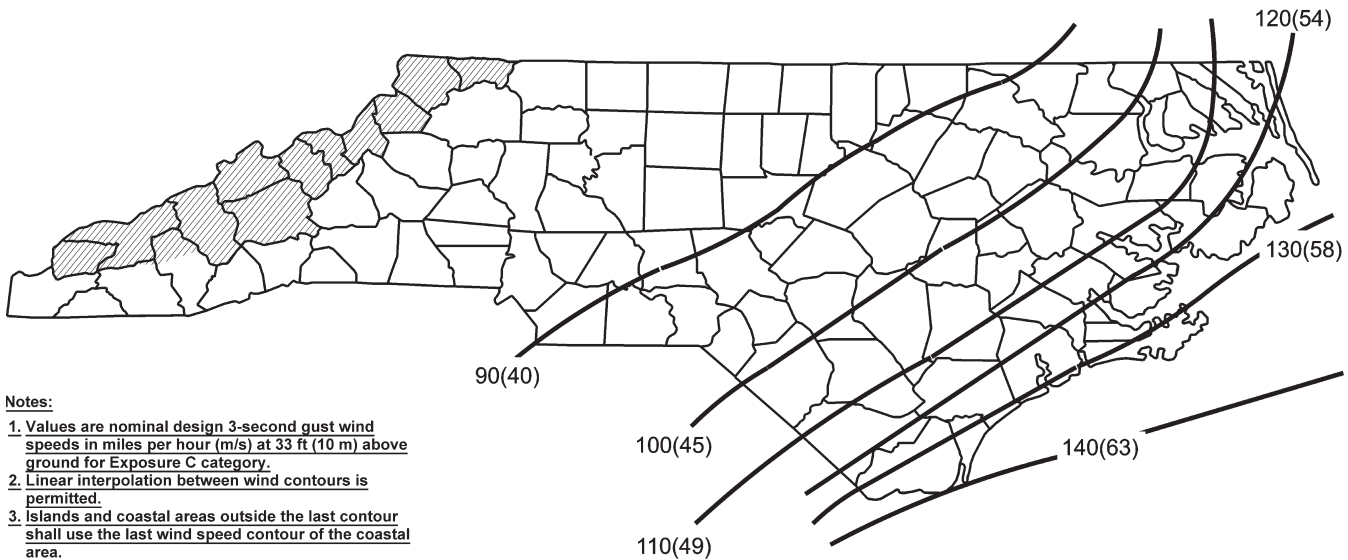

- Notes:**
- Values are nominal design 3-second gust wind speeds in miles per hour (m/s) at 33 ft (10 m) above ground for Exposure C category.
 - Linear interpolation between wind contours is permitted.
 - Islands and coastal areas outside the last contour shall use the last wind speed contour of the coastal area.
 - In special wind regions the design professional shall verify the wind speed with the local building official.

FIGURE 1609
NORTH CAROLINA BASIC WIND SPEED

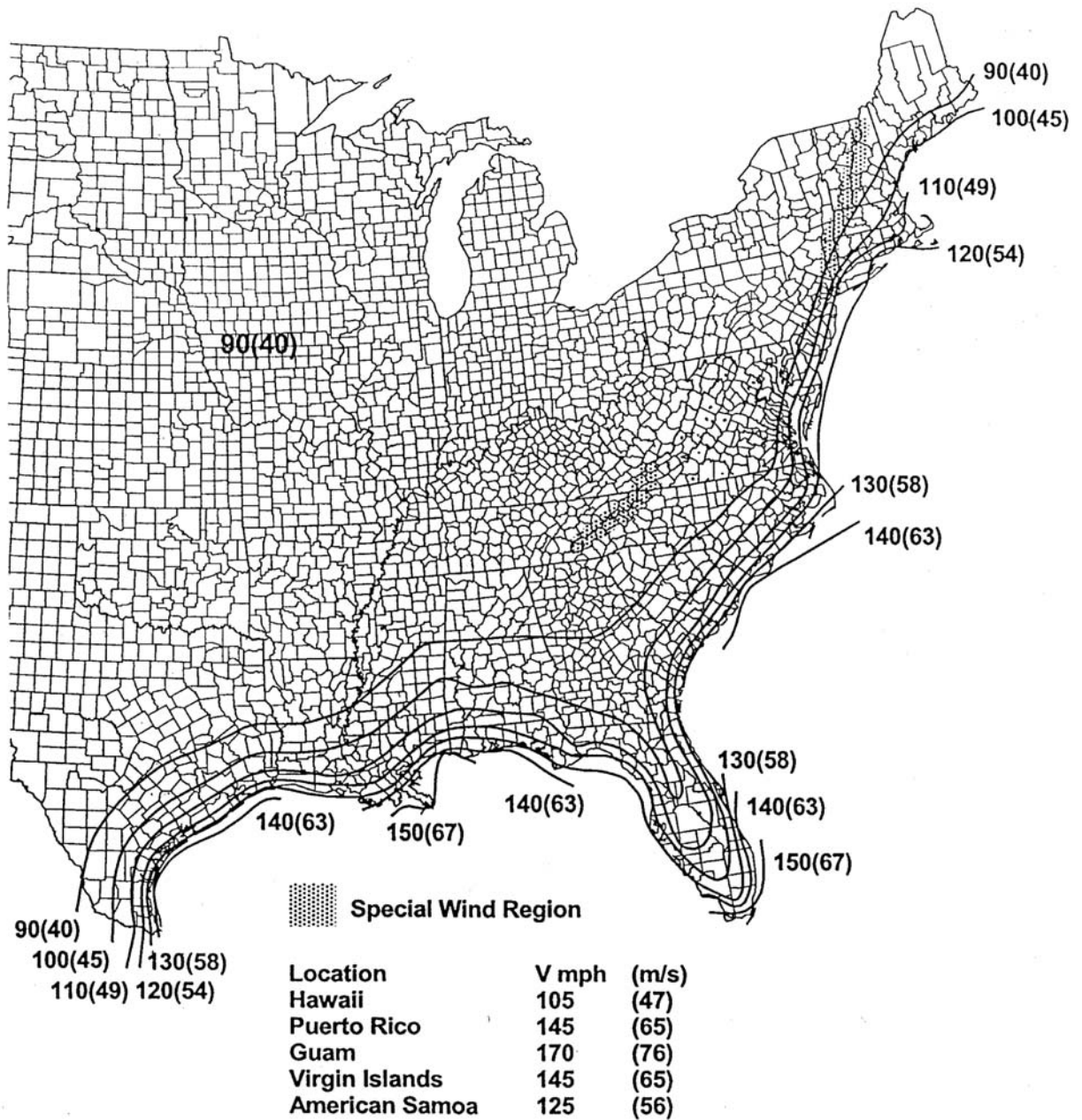

Notes:

1. Values are nominal design 3-second gust wind speeds in miles per hour (m/s) at 33 ft (10 m) above ground for Exposure C category.
2. Linear Interpolation between wind contours is permitted.
3. Islands and coastal areas outside the last contour shall use the last wind speed contour of the coastal area.
4. Mountainous terrain, gorges, ocean promontories, and special wind regions shall be examined for unusual wind conditions.

FIGURE 1609—continued
BASIC WIND SPEED (3-SECOND GUST)

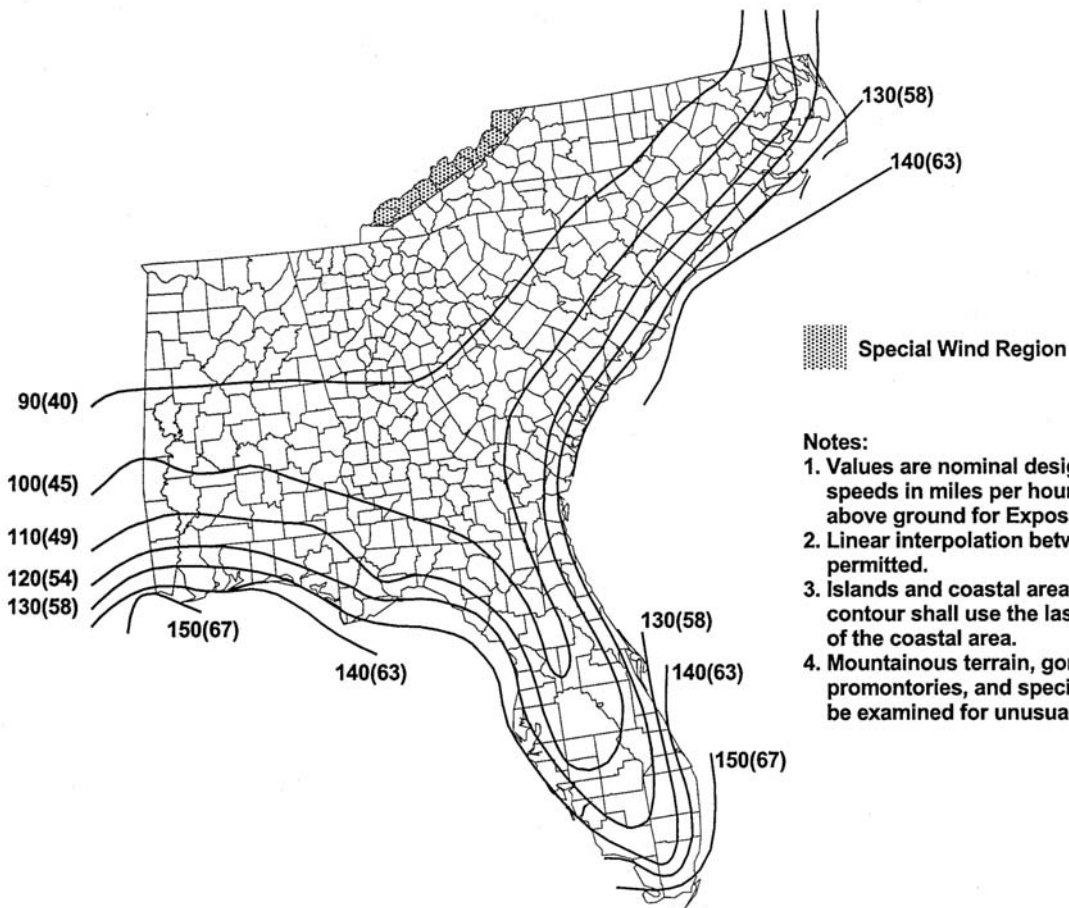

Notes:

1. Values are nominal design 3-second gust wind speeds in miles per hour (m/s) at 33 ft (10 m) above ground for Exposure C category.
2. Linear interpolation between wind contours is permitted.
3. Islands and coastal areas outside the last contour shall use the last wind speed contour of the coastal area.
4. Mountainous terrain, gorges, ocean promontories, and special wind regions shall be examined for unusual wind conditions.

FIGURE 1609—continued
 BASIC WIND SPEED (3-SECOND GUST)
 EASTERN GULF OF MEXICO AND SOUTHEASTERN U.S. HURRICANE COASTLINE

1609.3.1 Wind speed conversion. When required, the 3-second gust basic wind speeds of Figure 1609 shall be converted to fastest-mile wind speeds, V_{fm} , using Table 1609.3.1 or Equation 16-32.

$$V_{fm} = \frac{(V_{3s} - 10.5)}{1.05} \quad \text{(Equation 16-32)}$$

where:

V_{3s} = 3-second gust basic wind speed from Figure 1609.

1609.4 Exposure category. For each wind direction considered, an exposure category that adequately reflects the characteristics of ground surface irregularities shall be determined for the site at which the building or structure is to be constructed. Account shall be taken of variations in ground surface roughness that arise from natural topography and vegetation as well as from constructed features.

1609.4.1 Wind directions and sectors. For each selected wind direction at which the wind loads are to be evaluated, the exposure of the building or structure shall be determined for the two upwind sectors extending 45 degrees (0.79 rad) either side of the selected wind direction. The exposures in these two sectors shall be determined in accordance with Sections 1609.4.2 and 1609.4.3 and the exposure resulting in the highest wind loads shall be used to represent winds from that direction.

1609.4.2 Surface roughness categories. A ground surface roughness within each 45-degree (0.79 rad) sector shall be determined for a distance upwind of the site as defined in Section 1609.4.3 from the categories defined below, for the purpose of assigning an exposure category as defined in Section 1609.4.3.

Surface Roughness B. Urban and suburban areas, wooded areas or other terrain with numerous closely spaced obstructions having the size of single-family dwellings or larger.

Surface Roughness C. Open terrain with scattered obstructions having heights generally less than 30 feet (9144 mm). This category includes flat open country, grasslands, and all water surfaces in *hurricane-prone regions*.

Surface Roughness D. Flat, unobstructed areas and water surfaces outside *hurricane-prone regions*. This category includes smooth mud flats, salt flats and unbroken ice.

1609.4.3 Exposure categories. An exposure category shall be determined in accordance with the following:

Exposure B. Exposure B shall apply where the ground surface roughness condition, as defined by Surface Roughness B, prevails in the upwind direction for a distance of at least 2,600 feet (792 m) or 20 times the height of the building, whichever is greater.

Exception: For buildings whose mean roof height is less than or equal to 30 feet (9144 mm), the upwind distance is permitted to be reduced to 1,500 feet (457 m).

Exposure C. Exposure C shall apply for all cases where Exposures B or D do not apply.

Exposure D. Exposure D shall apply where the ground surface roughness, as defined by Surface Roughness D, prevails in the upwind direction for a distance of at least 5,000 feet (1524 m) or 20 times the height of the building, whichever is greater. Exposure D shall extend inland from the shoreline for a distance of 600 feet (183 m) or 20 times the height of the building, whichever is greater.

1609.5 Roof systems.

1609.5.1 Roof deck. The roof deck shall be designed to withstand the wind pressures determined in accordance with ASCE 7.

1609.5.2 Roof coverings. Roof coverings shall comply with Section 1609.5.1.

Exception: Rigid tile roof coverings that are air permeable and installed over a roof deck complying with Section 1609.5.1 are permitted to be designed in accordance with Section 1609.5.3.

Asphalt shingles installed over a roof deck complying with Section 1609.5.1 shall comply with the wind-resistance requirements of Section 1507.2.7.1.

1609.5.3 Rigid tile. Wind loads on rigid tile roof coverings shall be determined in accordance with the following equation:

$$M_a = q_h C_L b L L_a [1.0 - GC_p] \quad \text{(Equation 16-33)}$$

$$\text{For SI: } M_a = \frac{q_h C_L b L L_a [1.0 - GC_p]}{1,000}$$

where:

b = Exposed width, feet (mm) of the roof tile.

TABLE 1609.3.1
EQUIVALENT BASIC WIND SPEEDS^{a, b, c}

V_{3s}	85	90	100	105	110	120	125	130	140	145	150	160	170
V_{fm}	71	76	85	90	95	104	109	114	123	128	133	142	152

For SI: 1 mile per hour = 0.447 m/s.

- a. Linear interpolation is permitted.
- b. V_{3s} is the 3-second gust wind speed (mph).
- c. V_{fm} is the fastest mile wind speed (mph).

- C_L = Lift coefficient. The lift coefficient for concrete and clay tile shall be 0.2 or shall be determined by test in accordance with Section 1716.2.
- GC_p = Roof pressure coefficient for each applicable roof zone determined from Chapter 6 of ASCE 7. Roof coefficients shall not be adjusted for internal pressure.
- L = Length, feet (mm) of the roof tile.
- L_a = Moment arm, feet (mm) from the axis of rotation to the point of uplift on the roof tile. The point of uplift shall be taken at $0.76L$ from the head of the tile and the middle of the exposed width. For roof tiles with nails or screws (with or without a tail clip), the axis of rotation shall be taken as the head of the tile for direct deck application or as the top edge of the batten for battened applications. For roof tiles fastened only by a nail or screw along the side of the tile, the axis of rotation shall be determined by testing. For roof tiles installed with battens and fastened only by a clip near the tail of the tile, the moment arm shall be determined about the top edge of the batten with consideration given for the point of rotation of the tiles based on straight bond or broken bond and the tile profile.
- M_a = Aerodynamic uplift moment, feet-pounds (N-mm) acting to raise the tail of the tile.
- q_h = Wind velocity pressure, psf (kN/m²) determined from Section 6.5.10 of ASCE 7.

Concrete and clay roof tiles complying with the following limitations shall be designed to withstand the aerodynamic uplift moment as determined by this section.

1. The roof tiles shall be either loose laid on battens, mechanically fastened, mortar set or adhesive set.
2. The roof tiles shall be installed on solid sheathing which has been designed as components and cladding.
3. An underlayment shall be installed in accordance with Chapter 15.
4. The tile shall be single lapped interlocking with a minimum head lap of not less than 2 inches (51 mm).
5. The length of the tile shall be between 1.0 and 1.75 feet (305 mm and 533 mm).
6. The exposed width of the tile shall be between 0.67 and 1.25 feet (204 mm and 381 mm).
7. The maximum thickness of the tail of the tile shall not exceed 1.3 inches (33 mm).
8. Roof tiles using mortar set or adhesive set systems shall have at least two-thirds of the tile's area free of mortar or adhesive contact.

1609.6 Alternate all-heights method. The alternate wind design provisions in this section are simplifications of the ASCE 7 Method 2—Analytical Procedure.

1609.6.1 Scope. As an alternative to ASCE 7 Section 6.5, the following provisions are permitted to be used to determine the wind effects on regularly shaped buildings, or other structures that are regularly shaped, which meet all of the following conditions:

1. The building or other structure is less than or equal to 75 feet (22 860 mm) in height with a height-to-least-width ratio of 4 or less, or the building or other structure has a fundamental frequency greater than or equal to 1 hertz.
2. The building or other structure is not sensitive to dynamic effects.
3. The building or other structure is not located on a site for which channeling effects or buffeting in the wake of upwind obstructions warrant special consideration.
4. The building shall meet the requirements of a simple diaphragm building as defined in ASCE 7 Section 6.2, where wind loads are only transmitted to the main wind-force-resisting system (MWFRS) at the diaphragms.
5. For open buildings, multispans gable roofs, stepped roofs, sawtooth roofs, domed roofs, roofs with slopes greater than 45 degrees (0.79 rad), solid free-standing walls and solid signs, and rooftop equipment, apply ASCE 7 provisions.

1609.6.1.1 Modifications. The following modifications shall be made to certain subsections in ASCE 7: in Section 1609.6.2, symbols and notations that are specific to this section are used in conjunction with the symbols and notations in ASCE 7 Section 6.3.

1609.6.2 Symbols and notations. Coefficients and variables used in the alternative all-heights method equations are as follows:

- C_{net} = Net-pressure coefficient based on $K_d [(G) (C_p) - (GC_{pi})]$, in accordance with Table 1609.6.2(2).
- G = Gust effect factor for rigid structures in accordance with ASCE 7 Section 6.5.8.1.
- K_d = Wind directionality factor in accordance with ASCE 7 Table 6-4.
- P_{net} = Design wind pressure to be used in determination of wind loads on buildings or other structures or their components and cladding, in psf (kN/m²).
- q_s = Wind stagnation pressure in psf (kN/m²) in accordance with Table 1609.6.2(1).

TABLE 1609.6.2(1)
WIND STAGNATION PRESSURE (q_s) AT STANDARD HEIGHT OF 33 FEET^a

BASIC WIND SPEED (mph)	85	90	100	105	110	120	125	130	140	150	160	170
PRESSURE, q_s (psf)	18.5	20.7	25.6	28.2	31.0	36.9	40.0	43.3	50.2	57.6	65.5	74.0

For SI: 1 foot = 304.8 mm, 1 mile per hour = 0.447 m/s, 1 pound per square foot = 47.88 Pa.
a. For basic wind speeds not shown, use $q_s = 0.00256 V^2$.

TABLE 1609.6.2(2)
NET PRESSURE COEFFICIENTS, $C_{net}^{a, b}$

STRUCTURE OR PART THEREOF	DESCRIPTION		C_{net} FACTOR			
			Enclosed		Partially enclosed	
	Walls:		+ Internal pressure	- Internal pressure	+ Internal pressure	- Internal pressure
1. Main wind-force-resisting frames and systems	Windward wall		0.43	0.73	0.11	1.05
	Leeward wall		-0.51	-0.21	-0.83	0.11
	Sidewall		-0.66	-0.35	-0.97	-0.04
	Parapet wall	Windward	1.28		1.28	
		Leeward	-0.85		-0.85	
	Roofs:		Enclosed		Partially enclosed	
	Wind perpendicular to ridge		+ Internal pressure	- Internal pressure	+ Internal pressure	- Internal pressure
	Leeward roof or flat roof		-0.66	-0.35	-0.97	-0.04
	Windward roof slopes					
	Slope = 2:12 (10°)	Condition 1	-1.09	-0.79	-1.41	-0.47
		Condition 2	-0.28	0.02	-0.60	0.34
	Slope = 4:12 (18°)	Condition 1	-0.73	-0.42	-1.04	-0.11
		Condition 2	-0.05	0.25	-0.37	0.57
	Slope = 5:12 (23°)	Condition 1	-0.58	-0.28	-0.90	0.04
		Condition 2	0.03	0.34	-0.29	0.65
	Slope = 6:12 (27°)	Condition 1	-0.47	-0.16	-0.78	0.15
		Condition 2	0.06	0.37	-0.25	0.68
	Slope = 7:12 (30°)	Condition 1	-0.37	-0.06	-0.68	0.25
		Condition 2	0.07	0.37	-0.25	0.69
	Slope = 9:12 (37°)	Condition 1	-0.27	0.04	-0.58	0.35
		Condition 2	0.14	0.44	-0.18	0.76
	Slope = 12:12 (45°)		0.14	0.44	-0.18	0.76
	Wind parallel to ridge and flat roofs		-1.09	-0.79	-1.41	-0.47
	Nonbuilding Structures: Chimneys, Tanks and Similar Structures:					
				h/D		
				1	7	25
	Square (Wind normal to face)			0.99	1.07	1.53
	Square (Wind on diagonal)			0.77	0.84	1.15
Hexagonal or Octagonal			0.81	0.97	1.13	
Round			0.65	0.81	0.97	
Open signs and lattice frameworks			Ratio of solid to gross area			
			< 0.1	0.1 to 0.29	0.3 to 0.7	
Flat			1.45	1.30	1.16	
Round			0.87	0.94	1.08	

(continued)

TABLE 1609.6.2(2)—continued
NET PRESSURE COEFFICIENTS, C_{net} ^{a, b}

STRUCTURE OR PART THEREOF	DESCRIPTION	C_{net} FACTOR		
		Enclosed	Partially enclosed	
2. Components and cladding not in areas of discontinuity—roofs and overhangs	Roof elements and slopes	Enclosed	Partially enclosed	
	Gable of hipped configurations (Zone 1)			
	Flat < Slope < 6:12 (27°) See ASCE 7 Figure 6-11C Zone 1			
	Positive	10 square feet or less	0.58	0.89
		100 square feet or more	0.41	0.72
	Negative	10 square feet or less	-1.00	-1.32
		100 square feet or more	-0.92	-1.23
	Overhang: Flat < Slope < 6:12 (27°) See ASCE 7 Figure 6-11B Zone 1			
	Negative	10 square feet or less	-1.45	
		100 square feet or more	-1.36	
		500 square feet or more	-0.94	
	6:12 (27°) < Slope < 12:12 (45°) See ASCE 7 Figure 6-11D Zone 1			
	Positive	10 square feet or less	0.92	1.23
		100 square feet or more	0.83	1.15
	Negative	10 square feet or less	-1.00	-1.32
		100 square feet or more	-0.83	-1.15
	Monosloped configurations (Zone 1)		Enclosed	Partially enclosed
	Flat < Slope < 7:12 (30°) See ASCE 7 Figure 6-14B Zone 1			
	Positive	10 square feet or less	0.49	0.81
		100 square feet or more	0.41	0.72
Negative	10 square feet or less	-1.26	-1.57	
	100 square feet or more	-1.09	-1.40	
Tall flat-topped roofs $h > 60'$		Enclosed	Partially enclosed	
Flat < Slope < 2:12 (10°) (Zone 1) See ASCE 7 Figure 6-17 Zone 1				
Negative	10 square feet or less	-1.34	-1.66	
	500 square feet or more	-0.92	-1.23	

(continued)

**TABLE 1609.6.2(2)—continued
NET PRESSURE COEFFICIENTS, $C_{net}^{a, b}$**

STRUCTURE OR PART THEREOF	DESCRIPTION	C_{net} FACTOR		
		Enclosed	Partially enclosed	
3. Components and cladding in areas of discontinuities—roofs and overhangs	Roof elements and slopes		Enclosed	Partially enclosed
	Gable or hipped configurations at ridges, eaves and rakes (Zone 2)			
	Flat < Slope < 6:12 (27°) See ASCE 7 Figure 6-11C Zone 2			
	Positive	10 square feet or less	0.58	0.89
		100 square feet or more	0.41	10.72
	Negative	10 square feet or less	-1.68	-2.00
		100 square feet or more	-1.17	-1.49
	Overhang for Slope Flat < Slope < 6:12 (27°) See ASCE 7 Figure 6-11C Zone 2			
	Negative	10 square feet or less	-1.87	
		100 square feet or more	-1.87	
	6:12 (27°) < Slope < 12:12 (45°) Figure 6-11D		Enclosed	Partially enclosed
	Positive	10 square feet or less	0.92	1.23
		100 square feet or more	0.83	1.15
	Negative	10 square feet or less	-1.17	-1.49
		100 square feet or more	-1.00	-1.32
	Overhang for 6:12 (27°) < Slope < 12:12 (45°) See ASCE 7 Figure 6-11D Zone 2			
	Negative	10 square feet or less	-1.70	
		500 square feet or more	-1.53	
	Monosloped configurations at ridges, eaves and rakes (Zone 2)			
	Flat < Slope < 7:12 (30°) See ASCE 7 Figure 6-14B Zone 2			
	Positive	10 square feet or less	0.49	0.81
		100 square feet or more	0.41	0.72
	Negative	10 square feet or less	-1.51	-1.83
		100 square feet or more	-1.43	-1.74
	Tall flat topped roofs $h > 60'$		Enclosed	Partially enclosed
	Flat < Slope < 2:12 (10°) (Zone 2) See ASCE 7 Figure 6-17 Zone 2			
	Negative	10 square feet or less	-2.11	-2.42
		500 square feet or more	-1.51	-1.83
	Gable or hipped configurations at corners (Zone 3) See ASCE 7 Figure 6-11C Zone 3			
	Flat < Slope < 6:12 (27°)		Enclosed	Partially enclosed
Positive	10 square feet or less	0.58	0.89	
	100 square feet or more	0.41	0.72	
Negative	10 square feet or less	-2.53	-2.85	
	100 square feet or more	-1.85	-2.17	

(continued)

TABLE 1609.6.2(2)—continued
NET PRESSURE COEFFICIENTS, C_{net} ^{a, b}

STRUCTURE OR PART THEREOF	DESCRIPTION		C_{net} FACTOR	
3. Components and cladding in areas of discontinuity—roofs and overhangs (continued)	Overhang for Slope Flat < Slope < 6:12 (27°) See ASCE 7 Figure 6-11C Zone 3			
	Negative	10 square feet or less	-3.15	
		100 square feet or more	-2.13	
	6:12 (27°) < 12:12 (45°) See ASCE 7 Figure 6-11D Zone 3			
	Positive	10 square feet or less	0.92	1.23
		100 square feet or more	0.83	1.15
	Negative	10 square feet or less	-1.17	-1.49
		100 square feet or more	-1.00	-1.32
	Overhang for 6:12 (27°) < Slope < 12:12 (45°)		Enclosed	Partially enclosed
	Negative	10 square feet or less	-1.70	
		100 square feet or more	-1.53	
	Monosloped Configurations at corners (Zone 3) See ASCE 7 Figure 6-14B Zone 3			
	Flat < Slope < 7:12 (30°)			
	Positive	10 square feet or less	0.49	0.81
		100 square feet or more	0.41	0.72
	Negative	10 square feet or less	-2.62	-2.93
		100 square feet or more	-1.85	-2.17
	Tall flat topped roofs $h > 60'$		Enclosed	Partially enclosed
Flat < Slope < 2:12 (10°) (Zone 3) See ASCE 7 Figure 6-17 Zone 3				
Negative	10 square feet or less	-2.87	-3.19	
	500 square feet or more	-2.11	-2.42	
4. Components and cladding not in areas of discontinuity—walls and parapets	Wall Elements: $h = 60'$ (Zone 4) Figure 6-11A			
	Positive	10 square feet or less	1.00	1.32
		500 square feet or more	0.75	1.06
	Negative	10 square feet or less	-1.09	-1.40
		500 square feet or more	-0.83	-1.15
	Wall Elements: $h > 60'$ (Zone 4) See ASCE 7 Figure 6-17 Zone 4			
	Positive	20 square feet or less	0.92	1.23
		500 square feet or more	0.66	0.98
	Negative	20 square feet or less	-0.92	-1.23
		500 square feet or more	-0.75	-1.06
	Parapet Walls			
Positive			2.87	3.19
Negative			-1.68	-2.00

**TABLE 1609.6.2(2)—continued
NET PRESSURE COEFFICIENTS, $C_{net}^{a,b}$**

STRUCTURE OR PART THEREOF	DESCRIPTION	C_{net} FACTOR		
		Enclosed	Partially enclosed	
5. Components and cladding in areas of discontinuity—walls and parapets	Wall elements: $h \leq 60'$ (Zone 5) Figure 6-11A		Enclosed	Partially enclosed
	Positive	10 square feet or less	1.00	1.32
		500 square feet or more	0.75	1.06
	Negative	10 square feet or less	-1.34	-1.66
		500 square feet or more	-0.83	-1.15
	Wall elements: $h > 60'$ (Zone 5) See ASCE 7 Figure 6-17 Zone 4			
	Positive	20 square feet or less	0.92	1.23
		500 square feet or more	0.66	0.98
	Negative	20 square feet or less	-1.68	-2.00
		500 square feet or more	-1.00	-1.32
	Parapet walls			
	Positive		3.64	3.95
	Negative		-2.45	-2.76

For SI: 1 foot = 304.8 mm, 1 square foot = 0.0929 m², 1 degree = 0.0175 rad.

a. Linear interpolation between values in the table is permitted.

b. Some C_{net} values have been grouped together. Less conservative results may be obtained by applying ASCE 7 provisions.

1609.6.3 Design equations. When using the alternative all-heights method, the MWFRS, and components and cladding of every structure shall be designed to resist the effects of wind pressures on the building envelope in accordance with Equation 16-34.

$$P_{net} = q_s K_z C_{net} [IK_{zt}] \quad \text{(Equation 16-34)}$$

Design wind forces for the MWFRS shall not be less than 10 psf (0.48 kN/m²) multiplied by the area of the structure projected on a plane normal to the assumed wind direction (see ASCE 7 Section 6.1.4 for criteria). Design net wind pressure for components and cladding shall not be less than 10 psf (0.48 kN/m²) acting in either direction normal to the surface.

1609.6.4 Design procedure. The MWFRS and the components and cladding of every building or other structure shall be designed for the pressures calculated using Equation 16-34.

1609.6.4.1 Main wind-force-resisting systems. The MWFRS shall be investigated for the torsional effects identified in ASCE 7 Figure 6-9.

1609.6.4.2 Determination of K_z and K_{zt} . Velocity pressure exposure coefficient, K_z , shall be determined in accordance with ASCE 7 Section 6.5.6.6 and the topographic factor, K_{zt} , shall be determined in accordance with ASCE 7 Section 6.5.7.

1. For the windward side of a structure, K_{zt} and K_z shall be based on height z .

2. For leeward and sidewalls, and for windward and leeward roofs, K_{zt} and K_z shall be based on mean roof height h .

1609.6.4.3 Determination of net pressure coefficients, C_{net} . For the design of the MWFRS and for components and cladding, the sum of the internal and external net pressure shall be based on the net pressure coefficient, C_{net} .

1. The pressure coefficient, C_{net} , for walls and roofs shall be determined from Table 1609.6.2(2).
2. Where C_{net} has more than one value, the more severe wind load condition shall be used for design.

1609.6.4.4 Application of wind pressures. When using the alternative all-heights method, wind pressures shall be applied simultaneously on, and in a direction normal to, all building envelope wall and roof surfaces.

1609.6.4.4.1 Components and cladding. Wind pressure for each component or cladding element is applied as follows using C_{net} values based on the effective wind area, A , contained within the zones in areas of discontinuity of width and/or length “a,” “2a” or “4a” at: corners of roofs and walls; edge strips for ridges, rakes and eaves; or field areas on walls or roofs as indicated in figures in tables in ASCE 7 as referenced in Table 1609.6.2(2) in accordance with the following:

1. Calculated pressures at local discontinuities acting over specific edge strips or corner boundary areas.
2. Include “field” (Zone 1, 2 or 4, as applicable) pressures applied to areas beyond the boundaries of the areas of discontinuity.
3. Where applicable, the calculated pressures at discontinuities (Zones 2 or 3) shall be combined with design pressures that apply specifically on rakes or eave overhangs.

**SECTION 1610
SOIL LATERAL LOADS**

1610.1 General. Foundation walls and retaining walls shall be designed to resist lateral soil loads. Soil loads specified in Table

1610.1 shall be used as the minimum design lateral soil loads unless determined otherwise by a geotechnical investigation in accordance with Section 1803. Foundation walls and other walls in which horizontal movement is restricted at the top shall be designed for at-rest pressure. Retaining walls free to move and rotate at the top shall be permitted to be designed for active pressure. Design lateral pressure from surcharge loads shall be added to the lateral earth pressure load. Design lateral pressure shall be increased if soils at the site are expansive. Foundation walls shall be designed to support the weight of the full hydrostatic pressure of undrained backfill unless a drainage system is installed in accordance with Sections 1805.4.2 and 1805.4.3.

Exception: Foundation walls extending not more than 8 feet (2438 mm) below grade and laterally supported at the top by flexible diaphragms shall be permitted to be designed for active pressure.

**TABLE 1610.1
LATERAL SOIL LOAD**

DESCRIPTION OF BACKFILL MATERIAL ^c	UNIFIED SOIL CLASSIFICATION	DESIGN LATERAL SOIL LOAD ^a (pound per square foot per foot of depth)	
		Active pressure	At-rest pressure
Well-graded, clean gravels; gravel-sand mixes	GW	30	60
Poorly graded clean gravels; gravel-sand mixes	GP	30	60
Silty gravels, poorly graded gravel-sand mixes	GM	40	60
Clayey gravels, poorly graded gravel-and-clay mixes	GC	45	60
Well-graded, clean sands; gravelly sand mixes	SW	30	60
Poorly graded clean sands; sand-gravel mixes	SP	30	60
Silty sands, poorly graded sand-silt mixes	SM	45	60
Sand-silt clay mix with plastic fines	SM-SC	45	100
Clayey sands, poorly graded sand-clay mixes	SC	60	100
Inorganic silts and clayey silts	ML	45	100
Mixture of inorganic silt and clay	ML-CL	60	100
Inorganic clays of low to medium plasticity	CL	60	100
Organic silts and silt clays, low plasticity	OL	Note b	Note b
Inorganic clayey silts, elastic silts	MH	Note b	Note b
Inorganic clays of high plasticity	CH	Note b	Note b
Organic clays and silty clays	OH	Note b	Note b

For SI: 1 pound per square foot per foot of depth = 0.157 kPa/m, 1 foot = 304.8 mm.

- a. Design lateral soil loads are given for moist conditions for the specified soils at their optimum densities. Actual field conditions shall govern. Submerged or saturated soil pressures shall include the weight of the buoyant soil plus the hydrostatic loads.
- b. Unsuitable as backfill material.
- c. The definition and classification of soil materials shall be in accordance with ASTM D 2487.

**SECTION 1611
RAIN LOADS**

1611.1 Design rain loads. Each portion of a roof shall be designed to sustain the load of rainwater that will accumulate on it if the primary drainage system for that portion is blocked plus the uniform load caused by water that rises above the inlet of the secondary drainage system at its design flow. The design rainfall shall be based on the 100-year hourly rainfall rate indicated in Figure 1611.1 or on other rainfall rates determined from *approved* local weather data.

$$R = 5.2(d_s + d_h) \quad \text{(Equation 16-35)}$$

For SI: $R = 0.0098(d_s + d_h)$

where:

d_h = Additional depth of water on the undeflected roof above the inlet of secondary drainage system at its design flow (i.e., the hydraulic head), in inches (mm).

d_s = Depth of water on the undeflected roof up to the inlet of secondary drainage system when the primary drainage system is blocked (i.e., the static head), in inches (mm).

R = Rain load on the undeflected roof, in psf (kN/m²). When the phrase “undeflected roof” is used, deflections from loads (including dead loads) shall not be considered when determining the amount of rain on the roof.

1611.2 Ponding instability. For roofs with a slope less than 1/4 inch per foot [1.19 degrees (0.0208 rad)], the design calculations shall include verification of adequate stiffness to preclude progressive deflection in accordance with Section 8.4 of ASCE 7.

1611.3 Controlled drainage. Roofs equipped with hardware to control the rate of drainage shall be equipped with a secondary drainage system at a higher elevation that limits accumulation of water on the roof above that elevation. Such roofs shall be designed to sustain the load of rainwater that will accumulate on them to the elevation of the secondary drainage system plus the uniform load caused by water that rises above the inlet of the secondary drainage system at its design flow determined from Section 1611.1. Such roofs shall also be checked for ponding instability in accordance with Section 1611.2.

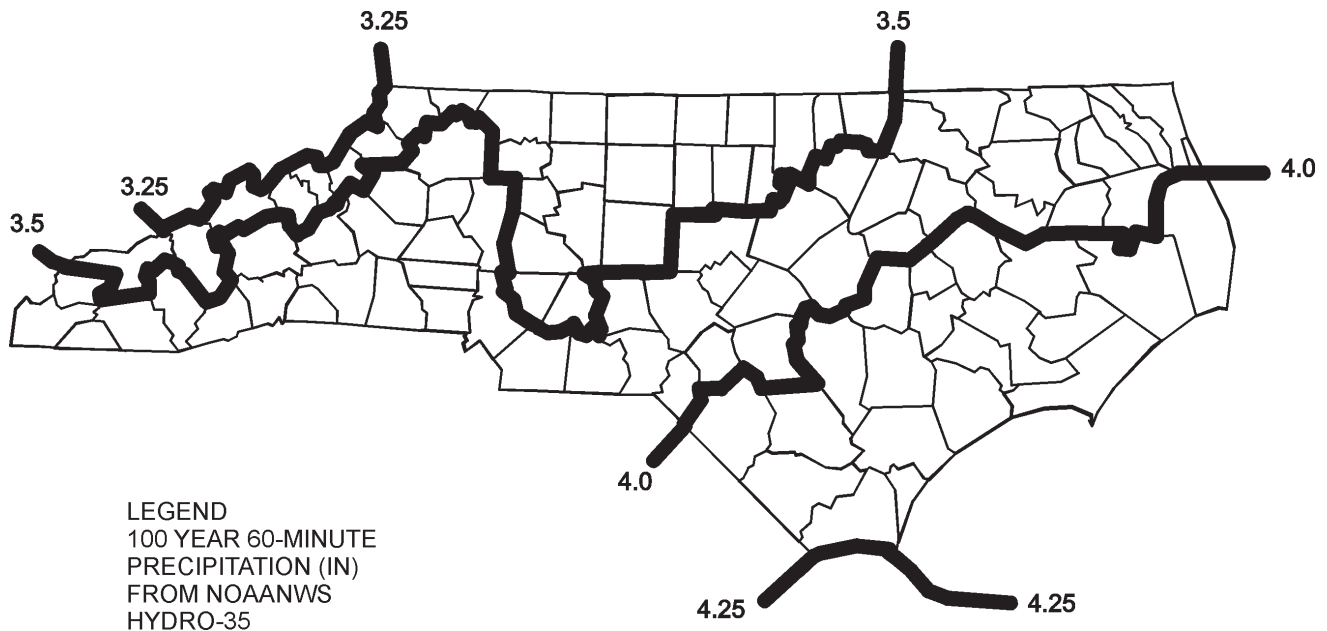

**FIGURE 1611.1
100-YEAR, 1-HOUR RAINFALL (INCHES/HOUR) NORTH CAROLINA FOR PRIMARY ROOF DRAINS**

For SI: 1 inch = 25.4 mm.

Source: National Weather Service, National Oceanic and Atmospheric Administration, Washington D.C.



[P] FIGURE 1611.1—continued
100-YEAR, 1-HOUR RAINFALL (INCHES) EASTERN UNITED STATES

For SI: 1 inch = 25.4 mm.

Source: National Weather Service, National Oceanic and Atmospheric Administration, Washington, DC.

SECTION 1612 FLOOD LOADS

1612.1 General. Within *flood hazard areas* as established in Section 1612.3, all new construction of buildings, structures and portions of buildings and structures, including substantial improvement and restoration of substantial damage to buildings and structures, shall be designed and constructed to resist the effects of flood hazards and flood loads. For buildings that are located in more than one *flood hazard area*, the provisions associated with the most restrictive *flood hazard area* shall apply.

1612.2 Definitions. The following words and terms shall, for the purposes of this section, have the meanings shown herein.

BASE FLOOD. The flood having a 1-percent chance of being equaled or exceeded in any given year.

BASE FLOOD ELEVATION. The elevation of the *base flood*, including wave height, relative to the National Geodetic Vertical Datum (NGVD), North American Vertical Datum (NAVD) or other datum specified on the Flood Insurance Rate Map (FIRM).

BASEMENT. The portion of a building having its floor subgrade (below ground level) on all sides.

This definition of “Basement” is limited in application to the provisions of Section 1612 (see “Basement” in Section 502.1).

DESIGN FLOOD. The flood associated with the greater of the following two areas:

1. Area with a flood plain subject to a 1-percent or greater chance of flooding in any year; or
2. Area designated as a *flood hazard area* on a community’s flood hazard map, or otherwise legally designated.

DESIGN FLOOD ELEVATION. The elevation of the “*design flood*,” including wave height, relative to the datum specified on the community’s legally designated flood hazard map. In areas designated as Zone AO, the design flood elevation shall be the elevation of the highest existing grade of the building’s perimeter plus the depth number (in feet) specified on the flood hazard map. In areas designated as Zone AO where a depth number is not specified on the map, the depth number shall be taken as being equal to 2 feet (610 mm).

DRY FLOODPROOFING. A combination of design modifications that results in a building or structure, including the attendant utility and sanitary facilities, being water tight with walls substantially impermeable to the passage of water and with structural components having the capacity to resist loads as identified in ASCE 7.

EXISTING CONSTRUCTION. Any buildings and structures for which the “start of construction” commenced before the effective date of the community’s first flood plain management code, ordinance or standard. “Existing construction” is also referred to as “existing structures.”

EXISTING STRUCTURE. See “Existing construction.”

FLOOD or FLOODING. A general and temporary condition of partial or complete inundation of normally dry land from:

1. The overflow of inland or tidal waters.
2. The unusual and rapid accumulation or runoff of surface waters from any source.

FLOOD DAMAGE-RESISTANT MATERIALS. Any construction material capable of withstanding direct and prolonged contact with floodwaters without sustaining any damage that requires more than cosmetic repair.

FLOOD HAZARD AREA. The greater of the following two areas:

1. The area within a flood plain subject to a 1-percent or greater chance of flooding in any year.
2. The area designated as a *flood hazard area* on a community’s flood hazard map, or otherwise legally designated.

FLOOD HAZARD AREA SUBJECT TO HIGH-VELOCITY WAVE ACTION. Area within the *flood hazard area* that is subject to high-velocity wave action, and shown on a Flood Insurance Rate Map (FIRM) or other flood hazard map as Zone V, VO, VE or V1-30.

FLOOD INSURANCE RATE MAP (FIRM). An official map of a community on which the Federal Emergency Management Agency (FEMA) has delineated both the special flood hazard areas and the risk premium zones applicable to the community.

FLOOD INSURANCE STUDY. The official report provided by the Federal Emergency Management Agency containing the Flood Insurance Rate Map (FIRM), the Flood Boundary and Floodway Map (FBFM), the water surface elevation of the *base flood* and supporting technical data.

FLOODWAY. The channel of the river, creek or other watercourse and the adjacent land areas that must be reserved in order to discharge the *base flood* without cumulatively increasing the water surface elevation more than a designated height.

LOWEST FLOOR. The floor of the lowest enclosed area, including basement, but excluding any unfinished or flood-resistant enclosure, usable solely for vehicle parking, building access or limited storage provided that such enclosure is not built so as to render the structure in violation of this section.

SPECIAL FLOOD HAZARD AREA. The land area subject to flood hazards and shown on a Flood Insurance Rate Map or other flood hazard map as Zone A, AE, A1-30, A99, AR, AO, AH, V, VO, VE or V1-30.

START OF CONSTRUCTION. The date of issuance for new construction and substantial improvements to existing structures, provided the actual start of construction, repair, reconstruction, rehabilitation, *addition*, placement or other improvement is within 180 days after the date of issuance. The actual start of construction means the first placement of permanent construction of a building (including a manufactured home) on a site, such as the pouring of a slab or footings, installation of pilings or construction of columns.

Permanent construction does not include land preparation (such as clearing, excavation, grading or filling), the installation of streets or walkways, excavation for a basement, footings, piers or foundations, the erection of temporary forms or

the installation of accessory buildings such as garages or sheds not occupied as *dwelling units* or not part of the main building. For a substantial improvement, the actual “start of construction” means the first *alteration* of any wall, ceiling, floor or other structural part of a building, whether or not that *alteration* affects the external dimensions of the building.

SUBSTANTIAL DAMAGE. Damage of any origin sustained by a structure whereby the cost of restoring the structure to its before-damaged condition would equal or exceed 50 percent of the market value of the structure before the damage occurred.

SUBSTANTIAL IMPROVEMENT. Any repair, reconstruction, rehabilitation, *addition* or improvement of a building or structure, the cost of which equals or exceeds 50 percent of the market value of the structure before the improvement or repair is started. If the structure has sustained substantial damage, any repairs are considered substantial improvement regardless of the actual repair work performed. The term does not, however, include either:

1. Any project for improvement of a building required to correct existing health, sanitary or safety code violations identified by the *building official* and that are the minimum necessary to assure safe living conditions.
2. Any *alteration* of a historic structure provided that the *alteration* will not preclude the structure’s continued designation as a historic structure.

1612.3 Establishment of flood hazard areas. To establish *flood hazard areas*, the applicable governing authority shall adopt a flood hazard map and supporting data. The flood hazard map shall include, at a minimum, areas of special flood hazard as identified by the Federal Emergency Management Agency in an engineering report entitled “The Flood Insurance Study for [INSERT NAME OF JURISDICTION],” dated [INSERT DATE OF ISSUANCE], as amended or revised with the accompanying Flood Insurance Rate Map (FIRM) and Flood Boundary and Floodway Map (FBFM) and related supporting data along with any revisions thereto. The adopted flood hazard map and supporting data are hereby adopted by reference and declared to be part of this section.

1612.3.1 Design flood elevations. Where design flood elevations are not included in the *flood hazard areas* established in Section 1612.3, or where floodways are not designated, the *building official* is authorized to require the applicant to:

1. Obtain and reasonably utilize any design flood elevation and floodway data available from a federal, state or other source; or
2. Determine the design flood elevation and/or floodway in accordance with accepted hydrologic and hydraulic engineering practices used to define special flood hazard areas. Determinations shall be undertaken by a *registered design professional* who shall document that the technical methods used reflect currently accepted engineering practice.

1612.3.2 Determination of impacts. In riverine *flood hazard areas* where design flood elevations are specified but floodways have not been designated, the applicant shall provide a floodway analysis that demonstrates that the pro-

posed work will not increase the design flood elevation more than 1 foot (305 mm) at any point within the jurisdiction of the applicable governing authority.

1612.4 Design and construction. The design and construction of buildings and structures located in *flood hazard areas*, including flood hazard areas subject to high-velocity wave action, shall be in accordance with Chapter 5 of ASCE 7 and with ASCE 24.

1612.5 Flood hazard documentation. The following documentation shall be prepared and sealed by a *registered design professional* and submitted to the *building official*:

1. For construction in *flood hazard areas* not subject to high-velocity wave action:
 - 1.1. The elevation of the lowest floor, including the basement, as required by the lowest floor elevation inspection in Section 110.3.3.
 - 1.2. For fully enclosed areas below the design flood elevation where provisions to allow for the automatic entry and exit of floodwaters do not meet the minimum requirements in Section 2.6.2.1 of ASCE 24, *construction documents* shall include a statement that the design will provide for equalization of hydrostatic flood forces in accordance with Section 2.6.2.2 of ASCE 24.
 - 1.3. For dry floodproofed nonresidential buildings, *construction documents* shall include a statement that the dry floodproofing is designed in accordance with ASCE 24.
2. For construction in flood hazard areas subject to high-velocity wave action:
 - 2.1. The elevation of the bottom of the lowest horizontal structural member as required by the lowest floor elevation inspection in Section 110.3.3.
 - 2.2. *Construction documents* shall include a statement that the building is designed in accordance with ASCE 24, including that the pile or column foundation and building or structure to be attached thereto is designed to be anchored to resist flotation, collapse and lateral movement due to the effects of wind and flood loads acting simultaneously on all building components, and other load requirements of Chapter 16.
 - 2.3. For breakaway walls designed to resist a nominal load of less than 10 psf (0.48 kN/m²) or more than 20 psf (0.96 kN/m²), *construction documents* shall include a statement that the breakaway wall is designed in accordance with ASCE 24.

SECTION 1613 EARTHQUAKE LOADS

1613.1 Scope. Every structure, and portion thereof, including nonstructural components that are permanently attached to structures and their supports and attachments, shall be designed and constructed to resist the effects of earthquake motions in accordance with ASCE 7, excluding Chapter 14 and

Appendix 11A. The *seismic design category* for a structure is permitted to be determined in accordance with Section 1613 or ASCE 7.

Exceptions:

1. Detached one- and two-family dwellings, assigned to *Seismic Design Category A, B or C*, or located where the mapped short-period spectral response acceleration, S_s , is less than 0.4 g.
2. The seismic-force-resisting system of wood-frame buildings that conform to the provisions of Section 2308 are not required to be analyzed as specified in this section.
3. Agricultural storage structures intended only for incidental human occupancy.
4. Structures that require special consideration of their response characteristics and environment that are not addressed by this code or ASCE 7 and for which other regulations provide seismic criteria, such as vehicular bridges, electrical transmission towers, hydraulic structures, buried utility lines and their appurtenances and nuclear reactors.

1613.2 Definitions. The following words and terms shall, for the purposes of this section, have the meanings shown herein.

DESIGN EARTHQUAKE GROUND MOTION. The earthquake ground motion that buildings and structures are specifically proportioned to resist in Section 1613.

MAXIMUM CONSIDERED EARTHQUAKE GROUND MOTION. The most severe earthquake effects considered by this code.

MECHANICAL SYSTEMS. For the purposes of determining seismic loads in ASCE 7, mechanical systems shall include plumbing systems as specified therein.

ORTHOGONAL. To be in two horizontal directions, at 90 degrees (1.57 rad) to each other.

SEISMIC DESIGN CATEGORY. A classification assigned to a structure based on its *occupancy category* and the severity of the design earthquake ground motion at the site.

SEISMIC-FORCE-RESISTING SYSTEM. That part of the structural system that has been considered in the design to provide the required resistance to the prescribed seismic forces.

SITE CLASS. A classification assigned to a site based on the types of soils present and their engineering properties as defined in Section 1613.5.2.

SITE COEFFICIENTS. The values of F_a and F_v indicated in Tables 1613.5.3(1) and 1613.5.3(2), respectively.

1613.3 Existing buildings. *Additions, alterations, repairs or change of occupancy of existing buildings shall be in accordance with Chapter 34.*

1613.4 Special inspections. Where required by Sections 1705.3 through 1705.3.5, the statement of special inspections

shall include the *special inspections* required by Section 1705.3.6.

1613.5 Seismic ground motion values. Seismic ground motion values shall be determined in accordance with this section.

1613.5.1 Mapped acceleration parameters. The parameters S_s and S_1 shall be determined from the 0.2 and 1-second spectral response accelerations shown on Figures 1613.5(1) through 1613.5(14). Where S_1 is less than or equal to 0.04 and S_s is less than or equal to 0.15, the structure is permitted to be assigned to *Seismic Design Category A*.

1613.5.2 Site class definitions. Based on the site soil properties, the site shall be classified as either *Site Class A, B, C, D, E or F* in accordance with Table 1613.5.2. When the soil properties are not known in sufficient detail to determine the *site class*, *Site Class D* shall be used unless the *building official* or geotechnical data determines that *Site Class E or F* soil is likely to be present at the site.

1613.5.3 Site coefficients and adjusted maximum considered earthquake spectral response acceleration parameters. The maximum considered earthquake spectral response acceleration for short periods, S_{MS} , and at 1-second period, S_{M1} , adjusted for *site class* effects shall be determined by Equations 16-36 and 16-37, respectively:

$$S_{MS} = F_a S_s \quad \text{(Equation 16-36)}$$

$$S_{M1} = F_v S_1 \quad \text{(Equation 16-37)}$$

where:

F_a = Site coefficient defined in Table 1613.5.3(1).

F_v = Site coefficient defined in Table 1613.5.3(2).

S_s = The mapped spectral accelerations for short periods as determined in Section 1613.5.1.

S_1 = The mapped spectral accelerations for a 1-second period as determined in Section 1613.5.1.

1613.5.4 Design spectral response acceleration parameters. Five-percent damped design spectral response acceleration at short periods, S_{DS} , and at 1-second period, S_{D1} , shall be determined from Equations 16-38 and 16-39, respectively:

$$S_{DS} = \frac{2}{3} S_{MS} \quad \text{(Equation 16-38)}$$

$$S_{D1} = \frac{2}{3} S_{M1} \quad \text{(Equation 16-39)}$$

where:

S_{MS} = The maximum considered earthquake spectral response accelerations for short period as determined in Section 1613.5.3.

S_{M1} = The maximum considered earthquake spectral response accelerations for 1-second period as determined in Section 1613.5.3.

**TABLE 1613.5.2
SITE CLASS DEFINITIONS**

SITE CLASS	SOIL PROFILE NAME	AVERAGE PROPERTIES IN TOP 100 feet, SEE SECTION 1613.5.5		
		Soil shear wave velocity, \bar{v}_s , (ft/s)	Standard penetration resistance, \bar{N}	Soil undrained shear strength, \bar{s}_u , (psf)
A	Hard rock	$\bar{v}_s > 5,000$	N/A	N/A
B	Rock	$2,500 < \bar{v}_s \leq 5,000$	N/A	N/A
C	Very dense soil and soft rock	$1,200 < \bar{v}_s \leq 2,500$	$\bar{N} > 50$	$\bar{s}_u \geq 2,000$
D	Stiff soil profile	$600 \leq \bar{v}_s \leq 1,200$	$15 \leq \bar{N} \leq 50$	$1,000 \leq \bar{s}_u \leq 2,000$
E	Soft soil profile	$\bar{v}_s < 600$	$\bar{N} < 15$	$\bar{s}_u < 1,000$
E	—	Any profile with more than 10 feet of soil having the following characteristics: 1. Plasticity index $PI > 20$, 2. Moisture content $w \geq 40\%$, and 3. Undrained shear strength $\bar{s}_u < 500$ psf		
F	—	Any profile containing soils having one or more of the following characteristics: 1. Soils vulnerable to potential failure or collapse under seismic loading such as liquefiable soils, quick and highly sensitive clays, collapsible weakly cemented soils. 2. Peats and/or highly organic clays ($H > 10$ feet of peat and/or highly organic clay where H = thickness of soil) 3. Very high plasticity clays ($H > 25$ feet with plasticity index $PI > 75$) 4. Very thick soft/medium stiff clays ($H > 120$ feet)		

**TABLE 1613.5.3(1)
VALUES OF SITE COEFFICIENT F_a ^a**

SITE CLASS	MAPPED SPECTRAL RESPONSE ACCELERATION AT SHORT PERIOD				
	$S_s \leq 0.25$	$S_s = 0.50$	$S_s = 0.75$	$S_s = 1.00$	$S_s \geq 1.25$
A	0.8	0.8	0.8	0.8	0.8
B	1.0	1.0	1.0	1.0	1.0
C	1.2	1.2	1.1	1.0	1.0
D	1.6	1.4	1.2	1.1	1.0
E	2.5	1.7	1.2	0.9	0.9
F	Note b	Note b	Note b	Note b	Note b

- a. Use straight-line interpolation for intermediate values of mapped spectral response acceleration at short period, S_s .
b. Values shall be determined in accordance with Section 11.4.7 of ASCE 7.

**TABLE 1613.5.3(2)
VALUES OF SITE COEFFICIENT F_v ^a**

SITE CLASS	MAPPED SPECTRAL RESPONSE ACCELERATION AT 1-SECOND PERIOD				
	$S_1 \leq 0.1$	$S_1 = 0.2$	$S_1 = 0.3$	$S_1 = 0.4$	$S_1 \geq 0.5$
A	0.8	0.8	0.8	0.8	0.8
B	1.0	1.0	1.0	1.0	1.0
C	1.7	1.6	1.5	1.4	1.3
D	2.4	2.0	1.8	1.6	1.5
E	3.5	3.2	2.8	2.4	2.4
F	Note b	Note b	Note b	Note b	Note b

- a. Use straight-line interpolation for intermediate values of mapped spectral response acceleration at 1-second period, S_1 .
b. Values shall be determined in accordance with Section 11.4.7 of ASCE 7.

1613.5.5 Site classification for seismic design. Site classification for *Site Class C, D or E* shall be determined from Table 1613.5.5.

The notations presented below apply to the upper 100 feet (30 480 mm) of the site profile. Profiles containing distinctly different soil and/or rock layers shall be subdivided into those layers designated by a number that ranges from 1 to *n* at the bottom where there is a total of *n* distinct layers in the upper 100 feet (30 480 mm). The symbol *i* then refers to any one of the layers between 1 and *n*.

where:

v_{si} = The shear wave velocity in feet per second (m/s).

d_i = The thickness of any layer between 0 and 100 feet (30 480 mm).

where:

$$\bar{v}_s = \frac{\sum_{i=1}^n d_i}{\sum_{i=1}^n \frac{d_i}{v_{si}}} \quad \text{(Equation 16-40)}$$

$$\sum_{i=1}^n d_i = 100 \text{ feet (30 480 mm)}$$

N_i is the Standard Penetration Resistance (ASTM D 1586) not to exceed 100 blows/foot (328 blows/m) as directly measured in the field without corrections. When refusal is met for a rock layer, N_i shall be taken as 100 blows/foot (328 blows/m).

$$\bar{N} = \frac{\sum_{i=1}^n d_i}{\sum_{i=1}^n \frac{d_i}{N_i}} \quad \text{(Equation 16-41)}$$

where N_i and d_i in Equation 16-41 are for cohesionless soil, cohesive soil and rock layers.

$$\bar{N}_{ch} = \frac{d_s}{\sum_{i=1}^m \frac{d_i}{N_i}} \quad \text{(Equation 16-42)}$$

where:

$$\sum_{i=1}^m d_i = d_s$$

Use d_i and N_i for cohesionless soil layers only in Equation 16-42.

d_s = The total thickness of cohesionless soil layers in the top 100 feet (30 480 mm).

m = The number of cohesionless soil layers in the top 100 feet (30 480 mm).

s_{ui} = The undrained shear strength in psf (kPa), not to exceed 5,000 psf (240 kPa), ASTM D 2166 or D 2850.

$$\bar{s}_u = \frac{d_c}{\sum_{i=1}^k \frac{d_i}{s_{ui}}} \quad \text{(Equation 16-43)}$$

where:

$$\sum_{i=1}^k d_i = d_c$$

d_c = The total thickness of cohesive soil layers in the top 100 feet (30 480 mm).

k = The number of cohesive soil layers in the top 100 feet (30 480 mm).

PI = The plasticity index, ASTM D 4318.

w = The moisture content in percent, ASTM D 2216.

Where a site does not qualify under the criteria for *Site Class F* and there is a total thickness of soft clay greater than 10 feet (3048 mm) where a soft clay layer is defined by: $\bar{s}_u < 500$ psf (24 kPa), $w \geq 40$ percent, and $PI > 20$, it shall be classified as *Site Class E*.

The shear wave velocity for rock, *Site Class B*, shall be either measured on site or estimated by a geotechnical engineer or engineering geologist/seismologist for competent rock with moderate fracturing and weathering. Softer and more highly fractured and weathered rock shall either be measured on site for shear wave velocity or classified as *Site Class C*.

The hard rock category, *Site Class A*, shall be supported by shear wave velocity measurements either on site or on profiles of the same rock type in the same formation with an equal or greater degree of weathering and fracturing. Where hard rock conditions are known to be continuous to a depth of 100 feet (30 480 mm), surficial shear wave velocity measurements are permitted to be extrapolated to assess \bar{v}_s .

**TABLE 1613.5.5
SITE CLASSIFICATION^a**

SITE CLASS	\bar{v}_s	\bar{N} or \bar{N}_{ch}	\bar{s}_u
E	< 600 ft/s	< 15	< 1,000 psf
D	600 to 1,200 ft/s	15 to 50	1,000 to 2,000 psf
C	1,200 to 2,500 ft/s	> 50	> 2,000

For SI: 1 foot per second = 304.8 mm per second, 1 pound per square foot = 0.0479 kN/m².

a. If the \bar{s}_u method is used and the \bar{N}_{ch} and \bar{s}_u criteria differ, select the category with the softer soils (for example, use Site Class E instead of D).

The rock categories, *Site Classes A* and *B*, shall not be used if there is more than 10 feet (3048 mm) of soil between the rock surface and the bottom of the spread footing or mat foundation.

1613.5.5.1 Steps for classifying a site.

1. Check for the four categories of *Site Class F* requiring site-specific evaluation. If the site corresponds to any of these categories, classify the site as *Site Class F* and conduct a site-specific evaluation.
2. Check for the existence of a total thickness of soft clay > 10 feet (3048 mm) where a soft clay layer is defined by: $\bar{s}_u < 500$ psf (24 kPa), $w \geq 40$ percent and $PI > 20$. If these criteria are satisfied, classify the site as *Site Class E*.
3. Categorize the site using one of the following three methods with \bar{v}_s , \bar{N} , and \bar{s}_u and computed in all cases as specified.
 - 3.1. \bar{v}_s for the top 100 feet (30 480 mm) (\bar{v}_s method).
 - 3.2. \bar{N} for the top 100 feet (30 480 mm) (N method).
 - 3.3. \bar{N}_{ch} for cohesionless soil layers ($PI < 20$) in the top 100 feet (30 480 mm) and average, \bar{s}_u for cohesive soil layers ($PI > 20$) in the top 100 feet (30 480 mm) (\bar{s}_u method).

1613.5.6 Determination of seismic design category. Structures classified as *Occupancy Category I, II* or *III* that are located where the mapped spectral response acceleration parameter at 1-second period, S_j , is greater than or equal to 0.75 shall be assigned to *Seismic Design Category E*. Structures classified as *Occupancy Category IV* that are located where the mapped spectral response acceleration parameter at 1-second period, S_j , is greater than or equal to 0.75 shall be assigned to *Seismic Design Category F*. All other structures shall be assigned to a *seismic design category* based on their *occupancy category* and the design spectral response acceleration coefficients, S_{DS} and S_{DI} , determined in accordance with Section 1613.5.4 or the site-specific procedures of ASCE 7. Each building and structure shall be assigned to the more severe *seismic design category* in accordance with Table 1613.5.6(1) or 1613.5.6(2), irrespective of the fundamental period of vibration of the structure, T .

**TABLE 1613.5.6(1)
SEISMIC DESIGN CATEGORY BASED ON
SHORT-PERIOD RESPONSE ACCELERATIONS**

VALUE OF S_{DS}	OCCUPANCY CATEGORY		
	I or II	III	IV
$S_{DS} < 0.167g$	A	A	A
$0.167g \leq S_{DS} < 0.33g$	B	B	C
$0.33g \leq S_{DS} < 0.50g$	C	C	D
$0.50g \leq S_{DS}$	D	D	D

**TABLE 1613.5.6(2)
SEISMIC DESIGN CATEGORY BASED ON
1-SECOND PERIOD RESPONSE ACCELERATION**

VALUE OF S_{DI}	OCCUPANCY CATEGORY		
	I or II	III	IV
$S_{DI} < 0.067g$	A	A	A
$0.067g \leq S_{DI} < 0.133g$	B	B	C
$0.133g \leq S_{DI} < 0.20g$	C	C	D
$0.20g \leq S_{DI}$	D	D	D

1613.5.6.1 Alternative seismic design category determination. Where S_j is less than 0.75, the *seismic design category* is permitted to be determined from Table 1613.5.6(1) alone when all of the following apply:

1. In each of the two orthogonal directions, the approximate fundamental period of the structure, T_a , in each of the two orthogonal directions determined in accordance with Section 12.8.2.1 of ASCE 7, is less than $0.8 T_s$ determined in accordance with Section 11.4.5 of ASCE 7.
2. In each of the two orthogonal directions, the fundamental period of the structure used to calculate the story drift is less than T_s .
3. Equation 12.8-2 of ASCE 7 is used to determine the seismic response coefficient, C_s .
4. The diaphragms are rigid as defined in Section 12.3.1 of ASCE 7 or, for diaphragms that are flexible, the distances between vertical elements of the seismic-force-resisting system do not exceed 40 feet (12 192 mm).

1613.5.6.2 Simplified design procedure. Where the alternate simplified design procedure of ASCE 7 is used, the *seismic design category* shall be determined in accordance with ASCE 7.

1613.6 Alternatives to ASCE 7. The provisions of Section 1613.6 shall be permitted as alternatives to the relevant provisions of ASCE 7.

1613.6.1 Assumption of flexible diaphragm. Add the following text at the end of Section 12.3.1.1 of ASCE 7.

Diaphragms constructed of wood structural panels or untopped steel decking shall also be permitted to be idealized as flexible, provided all of the following conditions are met:

1. Toppings of concrete or similar materials are not placed over wood structural panel diaphragms except for nonstructural toppings no greater than 1½ inches (38 mm) thick.
2. Each line of vertical elements of the seismic-force-resisting system complies with the allowable story drift of Table 12.12-1.
3. Vertical elements of the seismic-force-resisting system are light-frame walls sheathed with wood structural panels rated for shear resistance or steel sheets.

4. Portions of wood structural panel diaphragms that cantilever beyond the vertical elements of the lateral-force-resisting system are designed in accordance with Section 4.2.5.2 of AF&PA SDPWS.

1613.6.2 Additional seismic-force-resisting systems for seismically isolated structures. Add the following exception to the end of Section 17.5.4.2 of ASCE 7:

Exception: For isolated structures designed in accordance with this standard, the Structural System Limitations and the Building Height Limitations in Table 12.2-1 for ordinary steel concentrically braced frames (OCBFs) as defined in Chapter 11 and ordinary moment frames (OMFs) as defined in Chapter 11 are permitted to be taken as 160 feet (48 768 mm) for structures assigned to *Seismic Design Category* D, E or F, provided that the following conditions are satisfied:

1. The value of R_f as defined in Chapter 17 is taken as 1.
2. For OMFs and OCBFs, design is in accordance with AISC 341.

1613.6.3 Automatic sprinkler systems. *Automatic sprinkler systems* designed and installed in accordance with NFPA 13 shall be deemed to meet the requirements of Section 13.6.8 of ASCE 7.

1613.6.4 Autoclaved aerated concrete (AAC) masonry shear wall design coefficients and system limitations. Add the following text at the end of Section 12.2.1 of ASCE 7:

For ordinary reinforced AAC masonry shear walls used in the seismic-force-resisting system of structures, the response modification factor, R , shall be permitted to be taken as 2, the deflection amplification factor, C_d , shall be permitted to be taken as 2 and the system overstrength factor, Ω_o , shall be permitted to be taken as $2^{1/2}$. Ordinary reinforced AAC masonry shear walls shall not be limited in height for buildings assigned to *Seismic Design Category* B, shall be limited in height to 35 feet (10 668 mm) for buildings assigned to *Seismic Design Category* C and are not permitted for buildings assigned to *Seismic Design Categories* D, E and F.

For ordinary plain (unreinforced) AAC masonry shear walls used in the seismic-force-resisting system of structures, the response modification factor, R , shall be permitted to be taken as $1^{1/2}$, the deflection amplification factor, C_d , shall be permitted to be taken as $1^{1/2}$ and the system overstrength factor, Ω_o , shall be permitted to be taken as $2^{1/2}$. Ordinary plain (unreinforced) AAC masonry shear walls shall not be limited in height for buildings assigned to *Seismic Design Category* B and are not permitted for buildings assigned to *Seismic Design Categories* C, D, E and F.

1613.6.5 Seismic controls for elevators. Seismic switches in accordance with Section 8.4.10 of ASME A17.1 shall be deemed to comply with Section 13.6.10.3 of ASCE 7.

1613.6.6 Steel plate shear wall height limits. Modify Section 12.2.5.4 of ASCE 7 to read as follows:

12.2.5.4 Increased building height limit for steel-braced frames, special steel plate shear walls and special reinforced concrete shear walls. The height limits in Table 12.2-1 are permitted to be increased from 160 feet (48 768 mm) to 240 feet (75 152 mm) for structures assigned to *Seismic Design Category* D or E and from 100 feet (30 480 mm) to 160 feet (48 768 mm) for structures assigned to *Seismic Design Category* F that have steel-braced frames, special steel plate shear walls or special reinforced concrete cast-in-place shear walls and that meet both of the following requirements:

1. The structure shall not have an extreme torsional irregularity as defined in Table 12.2-1 (horizontal structural irregularity Type 1b).
2. The braced frames or shear walls in any one plane shall resist no more than 60 percent of the total seismic forces in each direction, neglecting accidental torsional effects.

1613.6.7 Minimum distance for building separation. All buildings and structures shall be separated from adjoining structures. Separations shall allow for the maximum inelastic response displacement (δ_M). δ_M shall be determined at critical locations with consideration for both translational and torsional displacements of the structure using Equation 16-44.

$$\delta_M = \frac{C_d \delta_{max}}{I} \quad \text{(Equation 16-44)}$$

where:

C_d = Deflection amplification factor in Table 12.2-1 of ASCE 7.

δ_{max} = Maximum displacement defined in Section 12.8.4.3 of ASCE 7.

I = Importance factor in accordance with Section 11.5.1 of ASCE 7.

Adjacent buildings on the same property shall be separated by a distance not less than δ_{MT} , determined by Equation 16-45.

$$\delta_{MT} = \sqrt{(\delta_{M1})^2 + (\delta_{M2})^2} \quad \text{(Equation 16-45)}$$

where:

δ_{M1} , δ_{M2} = The maximum inelastic response displacements of the adjacent buildings in accordance with Equation 16-44.

Where a structure adjoins a property line not common to a public way, the structure shall also be set back from the property line by not less than the maximum inelastic response displacement, δ_M , of that structure.

Exceptions:

1. Smaller separations or property line setbacks shall be permitted when justified by rational analyses.
2. Buildings and structures assigned to *Seismic Design Category* A, B or C.

1613.6.8 HVAC ductwork with $I_p = 1.5$. Seismic supports are not required for HVAC ductwork with $I_p = 1.5$ if either of the following conditions is met for the full length of each duct run:

1. HVAC ducts are suspended from hangers 12 inches (305 mm) or less in length with hangers detailed to avoid significant bending of the hangers and their attachments, or
2. HVAC ducts have a cross-sectional area of less than 6 square feet (0.557 m²).

1613.7 ASCE 7, Section 11.7.5. Modify ASCE 7, Section 11.7.5 to read as follows:

11.7.5 Anchorage of walls. Walls shall be anchored to the roof and all floors and members that provide lateral support for the wall or that are supported by the wall. The anchorage shall provide a direct connection between the walls and the roof or floor construction. The connections shall be capable of resisting the forces specified in Section 11.7.3 applied horizontally, substituted for E in load combinations of Section 2.3 or 2.4.

SECTION 1614 STRUCTURAL INTEGRITY

1614.1 General. Buildings classified as high-rise buildings in accordance with Section 403 and assigned to *Occupancy Category III* or *IV* shall comply with the requirements of this section. Frame structures shall comply with the requirements of Section 1614.3. Bearing wall structures shall comply with the requirements of Section 1614.4.

1614.2 Definitions. The following words and terms shall, for the purposes of Section 1614, have the meanings shown herein.

BEARING WALL STRUCTURE. A building or other structure in which vertical loads from floors and roofs are primarily supported by walls.

FRAME STRUCTURE. A building or other structure in which vertical loads from floors and roofs are primarily supported by columns.

1614.3 Frame structures. Frame structures shall comply with the requirements of this section.

1614.3.1 Concrete frame structures. Frame structures constructed primarily of reinforced or prestressed concrete, either cast-in-place or precast, or a combination of these, shall conform to the requirements of ACI 318 Sections 7.13, 13.3.8.5, 13.3.8.6, 16.5, 18.12.6, 18.12.7 and 18.12.8 as applicable. Where ACI 318 requires that nonprestressed reinforcing or prestressing steel pass through the region bounded by the longitudinal column reinforcement, that reinforcing or prestressing steel shall have a minimum nominal tensile strength equal to two-thirds of the required one-way vertical strength of the connection of the floor or roof system to the column in each direction of beam or slab reinforcement passing through the column.

Exception: Where concrete slabs with continuous reinforcing having an area not less than 0.0015 times the concrete area in each of two orthogonal directions are

present and are either monolithic with or equivalently bonded to beams, girders or columns, the longitudinal reinforcing or prestressing steel passing through the column reinforcement shall have a nominal tensile strength of one-third of the required one-way vertical strength of the connection of the floor or roof system to the column in each direction of beam or slab reinforcement passing through the column.

1614.3.2 Structural steel, open web steel joist or joist girder, or composite steel and concrete frame structures.

Frame structures constructed with a structural steel frame or a frame composed of open web steel joists, joist girders with or without other structural steel elements or a frame composed of composite steel or composite steel joists and reinforced concrete elements shall conform to the requirements of this section.

1614.3.2.1 Columns. Each column splice shall have the minimum design strength in tension to transfer the design dead and live load tributary to the column between the splice and the splice or base immediately below.

1614.3.2.2 Beams. End connections of all beams and girders shall have a minimum nominal axial tensile strength equal to the required vertical shear strength for *allowable stress design* (ASD) or two-thirds of the required shear strength for *load and resistance factor design* (LRFD) but not less than 10 kips (45 kN). For the purpose of this section, the shear force and the axial tensile force need not be considered to act simultaneously.

Exception: Where beams, girders, open web joist and joist girders support a concrete slab or concrete slab on metal deck that is attached to the beam or girder with not less than $\frac{3}{8}$ -inch-diameter (9.5 mm) headed shear studs, at a spacing of not more than 12 inches (305 mm) on center, averaged over the length of the member, or other attachment having equivalent shear strength, and the slab contains continuous distributed reinforcement in each of two orthogonal directions with an area not less than 0.0015 times the concrete area, the nominal axial tension strength of the end connection shall be permitted to be taken as half the required vertical shear strength for ASD or one-third of the required shear strength for LRFD, but not less than 10 kips (45 kN).

1614.4 Bearing wall structures. Bearing wall structures shall have vertical ties in all load-bearing walls and longitudinal ties, transverse ties and perimeter ties at each floor level in accordance with this section and as shown in Figure 1614.4.

1614.4.1 Concrete wall structures. Precast bearing wall structures constructed solely of reinforced or prestressed concrete, or combinations of these shall conform to the requirements of Sections 7.13, 13.3.8.5 and 16.5 of ACI 318.

1614.4.2 Other bearing wall structures. Ties in bearing wall structures other than those covered in Section 1614.4.1 shall conform to this section.

1614.4.2.1 Longitudinal ties. Longitudinal ties shall consist of continuous reinforcement in slabs; continuous or spliced decks or sheathing; continuous or spliced members framing to, within or across walls; or connections of continuous framing members to walls. Longitudinal ties shall extend across interior load-bearing walls and shall connect to exterior load-bearing walls and shall be spaced at not greater than 10 feet (3038 mm) on center. Ties shall have a minimum nominal tensile strength, T_T , given by Equation 16-46. For ASD the minimum nominal tensile strength shall be permitted to be taken as 1.5 times the allowable tensile stress times the area of the tie.

$$T_T = wLS \leq \alpha_T S \quad (\text{Equation 16-46})$$

where:

- L = The span of the horizontal element in the direction of the tie, between bearing walls, feet (m).
- w = The weight per unit area of the floor or roof in the span being tied to or across the wall, psf (N/m²).
- S = The spacing between ties, feet (m).
- α_T = A coefficient with a value of 1,500 pounds per foot (2.25 kN/m) for masonry bearing wall structures and a value of 375 pounds per foot (0.6 kN/m) for structures with bearing walls of cold-formed steel light-frame construction.

1614.4.2.2 Transverse ties. Transverse ties shall consist of continuous reinforcement in slabs; continuous or spliced decks or sheathing; continuous or spliced members framing to, within or across walls; or connections of continuous framing members to walls. Transverse ties shall be placed no farther apart than the spacing of load-bearing walls. Transverse ties shall have minimum nominal tensile strength T_T , given by Equation 16-46. For ASD the minimum nominal tensile strength shall be permitted to be taken as 1.5 times the allowable tensile stress times the area of the tie.

1614.4.2.3 Perimeter ties. Perimeter ties shall consist of continuous reinforcement in slabs; continuous or spliced decks or sheathing; continuous or spliced members framing to, within or across walls; or connections of continuous framing members to walls. Ties around the perimeter of each floor and roof shall be located within 4

feet (1219 mm) of the edge and shall provide a nominal strength in tension not less than T_p , given by Equation 16-47. For ASD the minimum nominal tensile strength shall be permitted to be taken as 1.5 times the allowable tensile stress times the area of the tie.

$$T_p = 200w \leq \beta_T \quad (\text{Equation 16-47})$$

For SI:

$$T_p = 90.7w \leq \beta_T$$

where:

w = As defined in Section 1614.4.2.1.

β_T = A coefficient with a value of 16,000 pounds (7200 kN) for structures with masonry bearing walls and a value of 4,000 pounds (1300 kN) for structures with bearing walls of cold-formed steel light-frame construction.

1614.4.2.4 Vertical ties. Vertical ties shall consist of continuous or spliced reinforcing, continuous or spliced members, wall sheathing or other engineered systems. Vertical tension ties shall be provided in bearing walls and shall be continuous over the height of the building. The minimum nominal tensile strength for vertical ties within a bearing wall shall be equal to the weight of the wall within that *story* plus the weight of the diaphragm tributary to the wall in the *story* below. No fewer than two ties shall be provided for each wall. The strength of each tie need not exceed 3,000 pounds per foot (450 kN/m) of wall tributary to the tie for walls of masonry construction or 750 pounds per foot (140 kN/m) of wall tributary to the tie for walls of cold-formed steel light-frame construction.

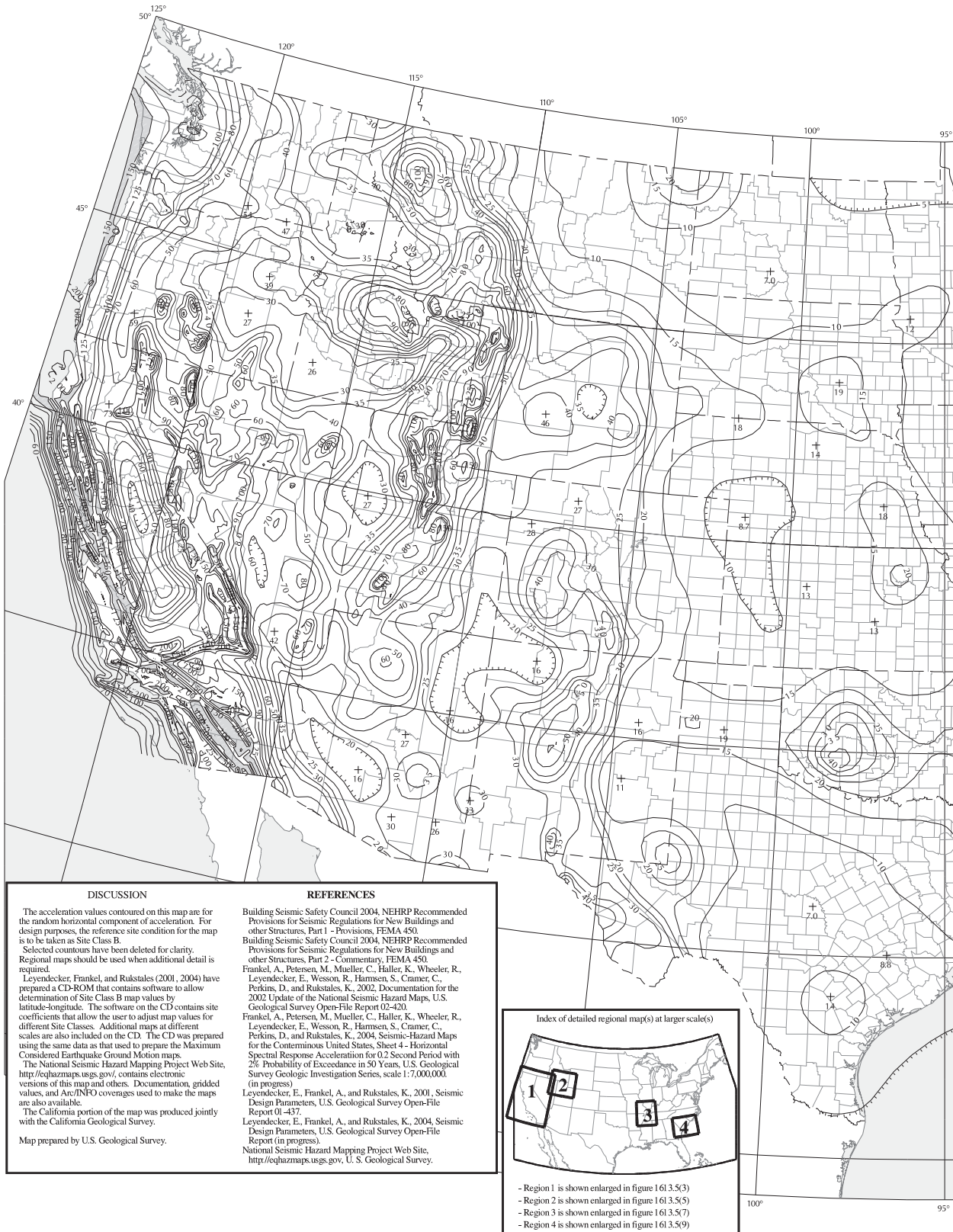

DISCUSSION

The acceleration values contoured on this map are for the random horizontal component of acceleration. For design purposes, the reference site condition for the map is to be taken as Site Class B.

Selected contours have been deleted for clarity. Regional maps should be used when additional detail is required.

Leyendecker, Frankel, and Rukstales (2001, 2004) have prepared a CD-ROM that contains software to allow determination of Site Class B map values by latitude-longitude. The software on the CD contains site coefficients that allow the user to adjust map values for different Site Classes. Additional maps at different scales are also included on the CD. The CD was prepared using the same data as that used to prepare the Maximum Considered Earthquake Ground Motion maps.

The National Seismic Hazard Mapping Project Web Site, <http://eqhazmaps.usgs.gov/>, contains electronic versions of this map and others. Documentation, gridded values, and Arc/INFO coverages used to make the maps are also available.

The California portion of the map was produced jointly with the California Geological Survey.

Map prepared by U.S. Geological Survey.

REFERENCES

Building Seismic Safety Council 2004, NEHRP Recommended Provisions for Seismic Regulations for New Buildings and other Structures, Part 1 - Provisions, FEMA 450.

Building Seismic Safety Council 2004, NEHRP Recommended Provisions for Seismic Regulations for New Buildings and other Structures, Part 2 - Commentary, FEMA 450.

Frankel, A., Petersen, M., Mueller, C., Haller, K., Wheeler, R., Leyendecker, E., Wesson, R., Harmsen, S., Cramer, C., Perkins, D., and Rukstales, K., 2002, Documentation for the 2002 Update of the National Seismic Hazard Maps, U.S. Geological Survey Open-File Report 02-420.

Frankel, A., Petersen, M., Mueller, C., Haller, K., Wheeler, R., Leyendecker, E., Wesson, R., Harmsen, S., Cramer, C., Perkins, D., and Rukstales, K., 2004, Seismic-Hazard Maps for the Conterminous United States, Sheet 4 - Horizontal Spectral Response Acceleration for 0.2 Second Period with 2% Probability of Exceedance in 50 Years, U.S. Geological Survey Geologic Investigation Series, scale 1:7,000,000, (in progress).

Leyendecker, E., Frankel, A., and Rukstales, K., 2001, Seismic Design Parameters, U.S. Geological Survey Open-File Report 01-437.

Leyendecker, E., Frankel, A., and Rukstales, K., 2004, Seismic Design Parameters, U.S. Geological Survey Open-File Report (in progress).

National Seismic Hazard Mapping Project Web Site, <http://eqhazmaps.usgs.gov/>, U.S. Geological Survey.

FIGURE 1613.5(1)
MAXIMUM CONSIDERED EARTHQUAKE GROUND MOTION FOR THE CONTERMINOUS UNITED STATES OF
0.2 SEC SPECTRAL RESPONSE ACCELERATION (5% OF CRITICAL DAMPING), SITE CLASS B

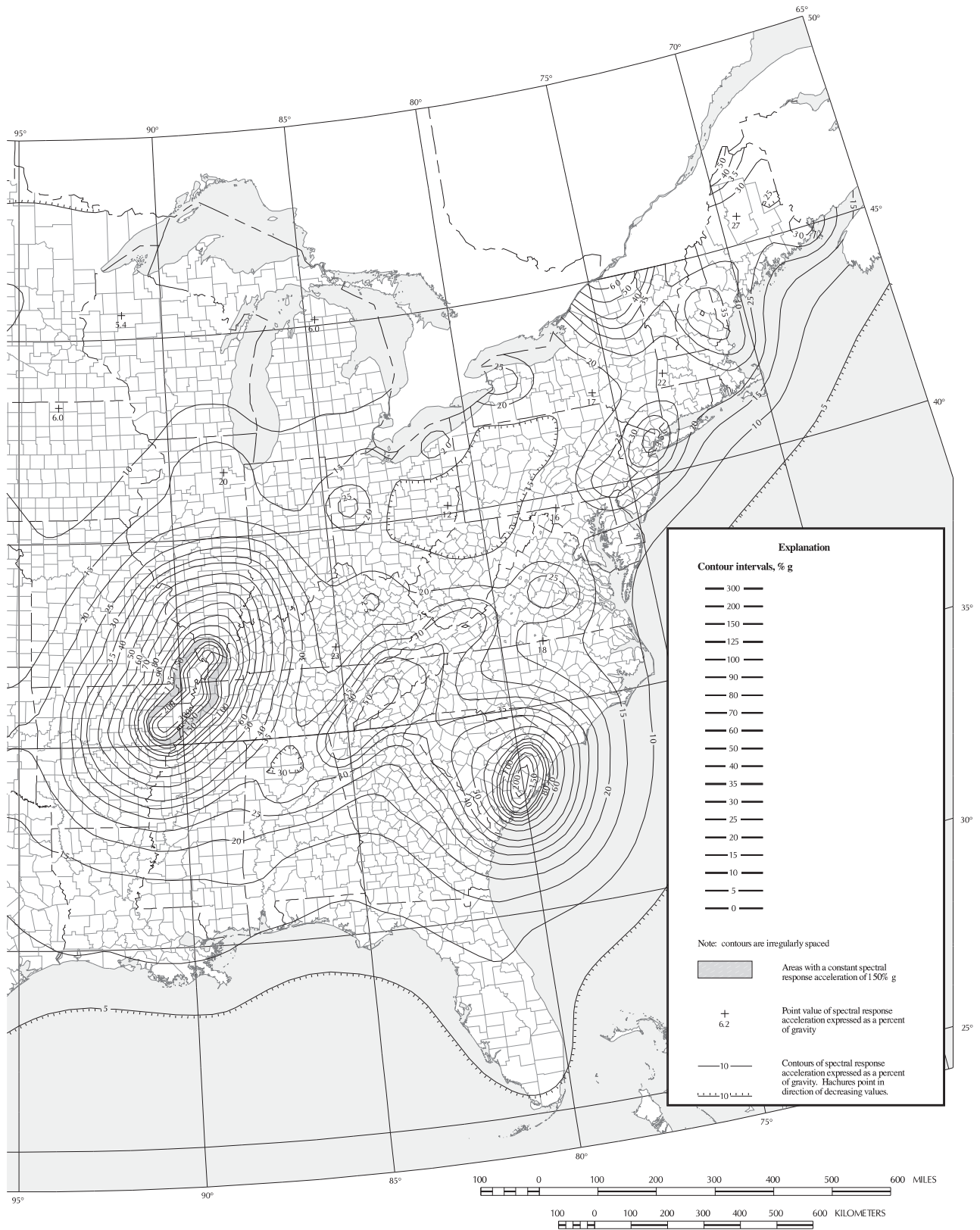
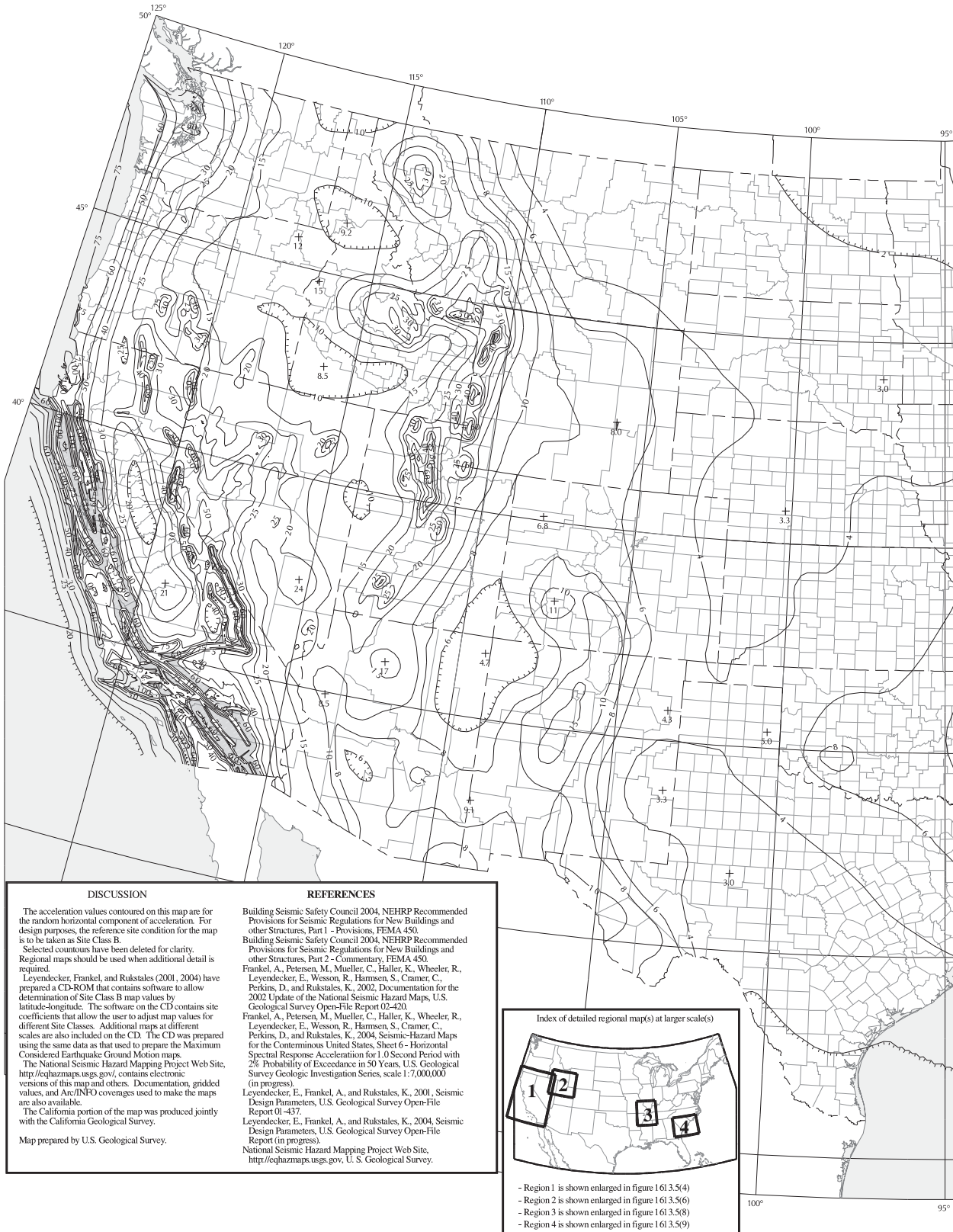

FIGURE 1613.5(1)—continued
MAXIMUM CONSIDERED EARTHQUAKE GROUND MOTION FOR THE CONTERMINOUS UNITED STATES OF
0.2 SEC SPECTRAL RESPONSE ACCELERATION (5% OF CRITICAL DAMPING), SITE CLASS B



DISCUSSION

The acceleration values contoured on this map are for the random horizontal component of acceleration. For design purposes, the reference site condition for the map is to be taken as Site Class B.

Selected contours have been deleted for clarity. Regional maps should be used when additional detail is required.

Leyendecker, Frankel, and Rukstales (2001, 2004) have prepared a CD-ROM that contains software to allow determination of Site Class B map values by latitude-longitude. The software on the CD contains site coefficients that allow the user to adjust map values for different Site Classes. Additional maps at different scales are also included on the CD. The CD was prepared using the same data as that used to prepare the Maximum Considered Earthquake Ground Motion maps.

The National Seismic Hazard Mapping Project Web Site, <http://eqhazmaps.usgs.gov/>, contains electronic versions of this map and others. Documentation, gridded values, and Arc/INFO coverages used to make the maps are also available.

The California portion of the map was produced jointly with the California Geological Survey.

Map prepared by U.S. Geological Survey.

REFERENCES

Building Seismic Safety Council 2004, NEHRP Recommended Provisions for Seismic Regulations for New Buildings and other Structures, Part 1 - Provisions, FEMA 450.

Building Seismic Safety Council 2004, NEHRP Recommended Provisions for Seismic Regulations for New Buildings and other Structures, Part 2 - Commentary, FEMA 450.

Frankel, A., Petersen, M., Mueller, C., Haller, K., Wheeler, R., Leyendecker, E., Wesson, R., Hammen, S., Cramer, C., Perkins, D., and Rukstales, K., 2002, Documentation for the 2002 Update of the National Seismic Hazard Maps, U.S. Geological Survey Open-File Report 02-420.

Frankel, A., Petersen, M., Mueller, C., Haller, K., Wheeler, R., Leyendecker, E., Wesson, R., Hammen, S., Cramer, C., Perkins, D., and Rukstales, K., 2004, Seismic-Hazard Maps for the Conterminous United States, Sheet 6 - Horizontal Spectral Response Acceleration for 1.0 Second Period with 2% Probability of Exceedence in 50 Years, U.S. Geological Survey Geologic Investigation Series, scale 1:7,000,000 (in progress).

Leyendecker, E., Frankel, A., and Rukstales, K., 2001, Seismic Design Parameters, U.S. Geological Survey Open-File Report 01-437.

Leyendecker, E., Frankel, A., and Rukstales, K., 2004, Seismic Design Parameters, U.S. Geological Survey Open-File Report (in progress).

National Seismic Hazard Mapping Project Web Site, <http://eqhazmaps.usgs.gov/>, U. S. Geological Survey.

FIGURE 1613.5(2)
MAXIMUM CONSIDERED EARTHQUAKE GROUND MOTION FOR THE CONTERMINOUS UNITED STATES
OF 1.0 SEC SPECTRAL RESPONSE ACCELERATION (5% OF CRITICAL DAMPING), SITE CLASS B

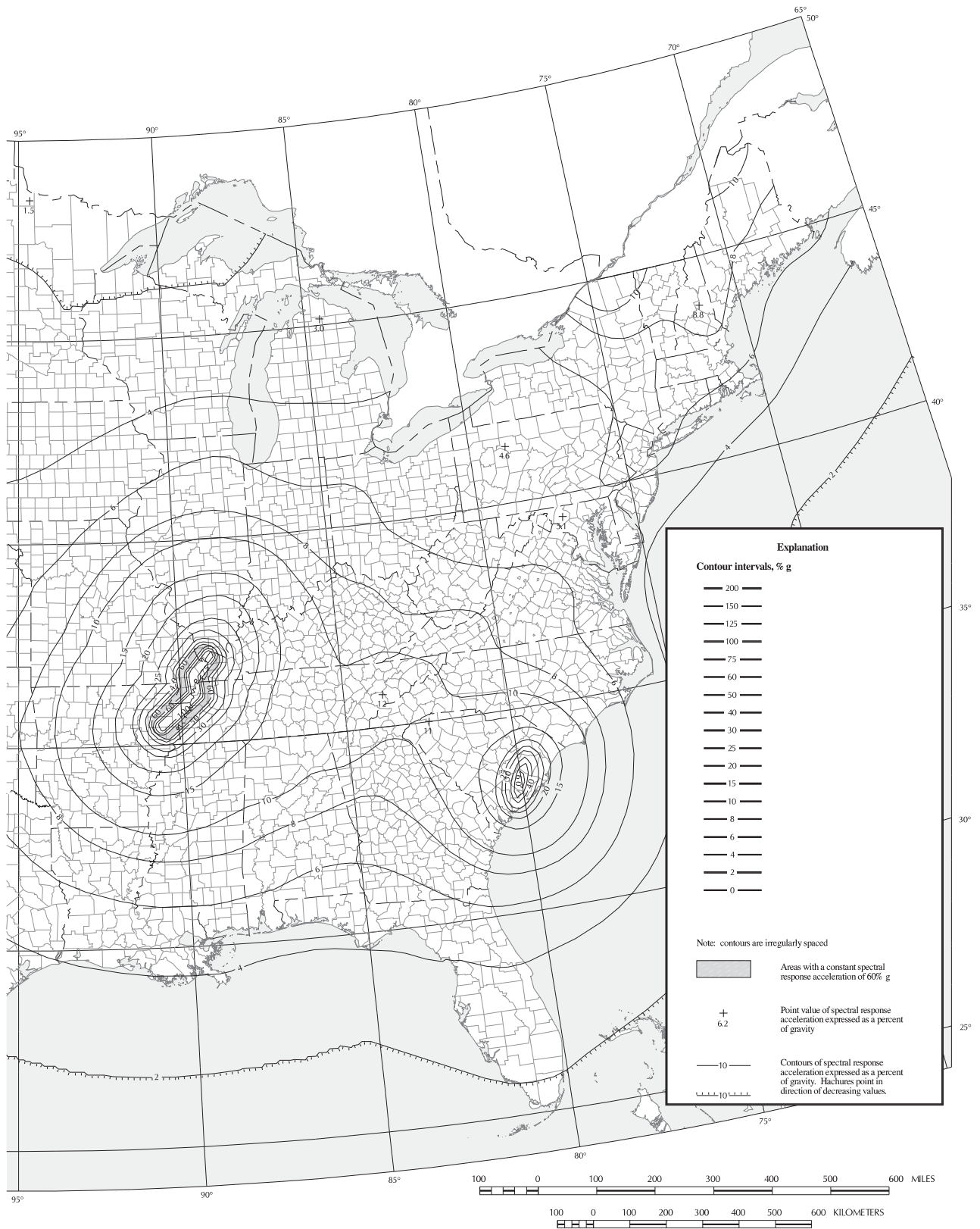

FIGURE 1613.5(2)—continued
MAXIMUM CONSIDERED EARTHQUAKE GROUND MOTION FOR THE CONTERMINOUS UNITED STATES
OF 1.0 SEC SPECTRAL RESPONSE ACCELERATION (5% OF CRITICAL DAMPING), SITE CLASS B

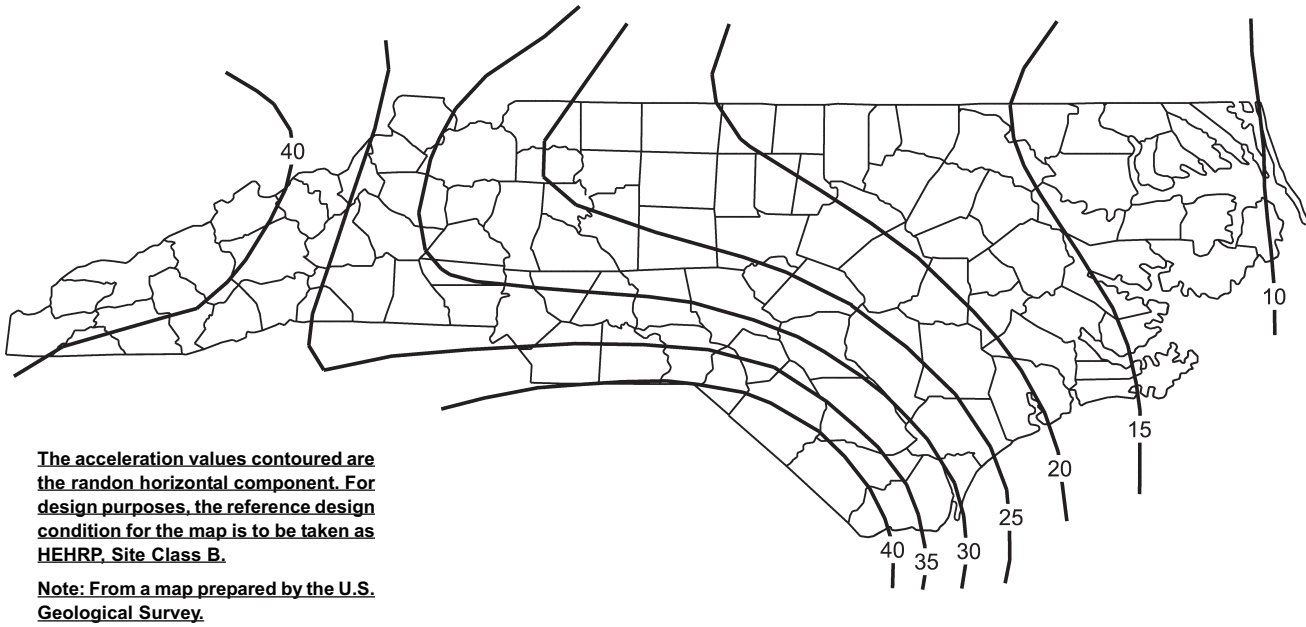

FIGURE 1613.5(3)
MAXIMUM CONSIDERED EARTHQUAKE GROUND MOTION FOR NORTH CAROLINA
OF 0.2 SECOND SPECTRAL RESPONSE ACCELERATION (5 PERCENT OF CRITICAL DAMPING), SITE CLASS B

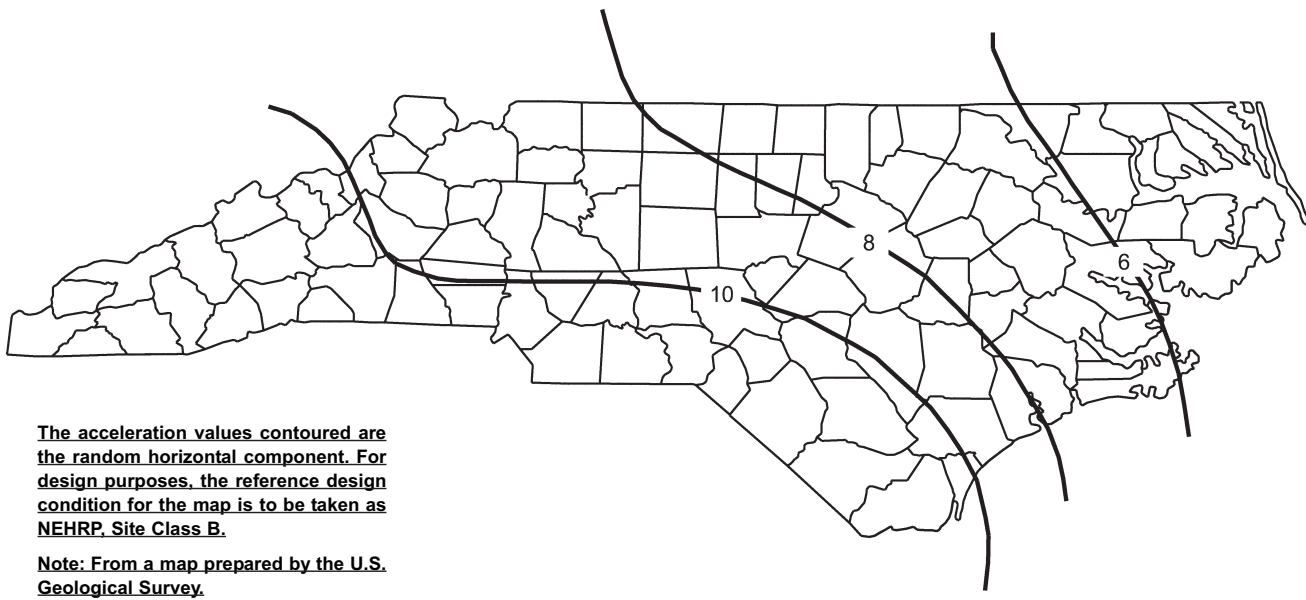

FIGURE 1613.5(4)
MAXIMUM CONSIDERED EARTHQUAKE GROUND MOTION FOR NORTH CAROLINA
OF 1.0 SECOND SPECTRAL RESPONSE ACCELERATION (5 PERCENT OF CRITICAL DAMPING), SITE CLASS B

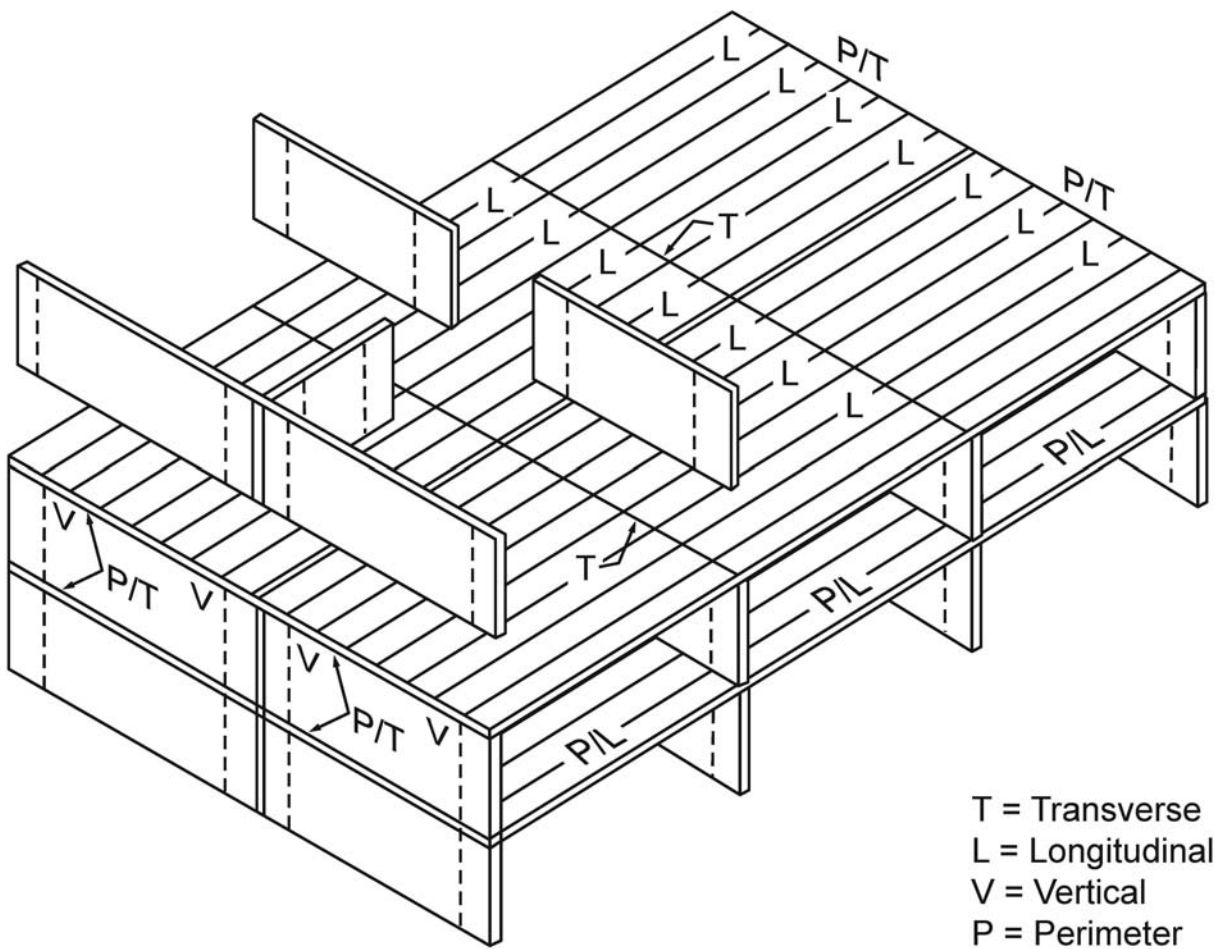

FIGURE 1614.4
 LONGITUDINAL, PERIMETER, TRANSVERSE AND VERTICAL TIES

